

1000



1000

1000

2011 2

2009 10

2X

X

	2018	9	2018	5	16	
2						(HJ/T55-2000)
3						HJ/T91-2002
4						GB12348-2008)
5						GB18599-2001
	2013.6					
1						1000
						2011 2
2						2011]85
1						
	1996	470				
2						

仅限江西华荣德金实业发展股份有限公司年产1000吨汽车配件项目公示

[2011]85

1000

pH CODcr BOD₅ NH₃-N SS

GB8978-1996 4

CB16297-19 2

GB18483-201

GB12348—2008 2

GB18599-2001

GB18597-2001

1-1

1-1

		/	pH 6~9	COD 400	BOD ₅ 150	SS 250	NH ₃ -N 30		10
		2					(15m)		
	GB 16297-1996			120			3.5		1.0
	GB18483-20 01	2		2.0			-		
	GB12348-20 08	2		60			55		
									GB18599-2001
									GB18597-2001

kg/h mg/L pH mg/m³
 GB8978-1996 4 dB(A)

仅限江西华荣德金实业发展股份有限公司年产1000吨汽车零部件项目公示

仅限江西华荣德金实业发展股份有限公司年产1000吨汽车零部件项目公示

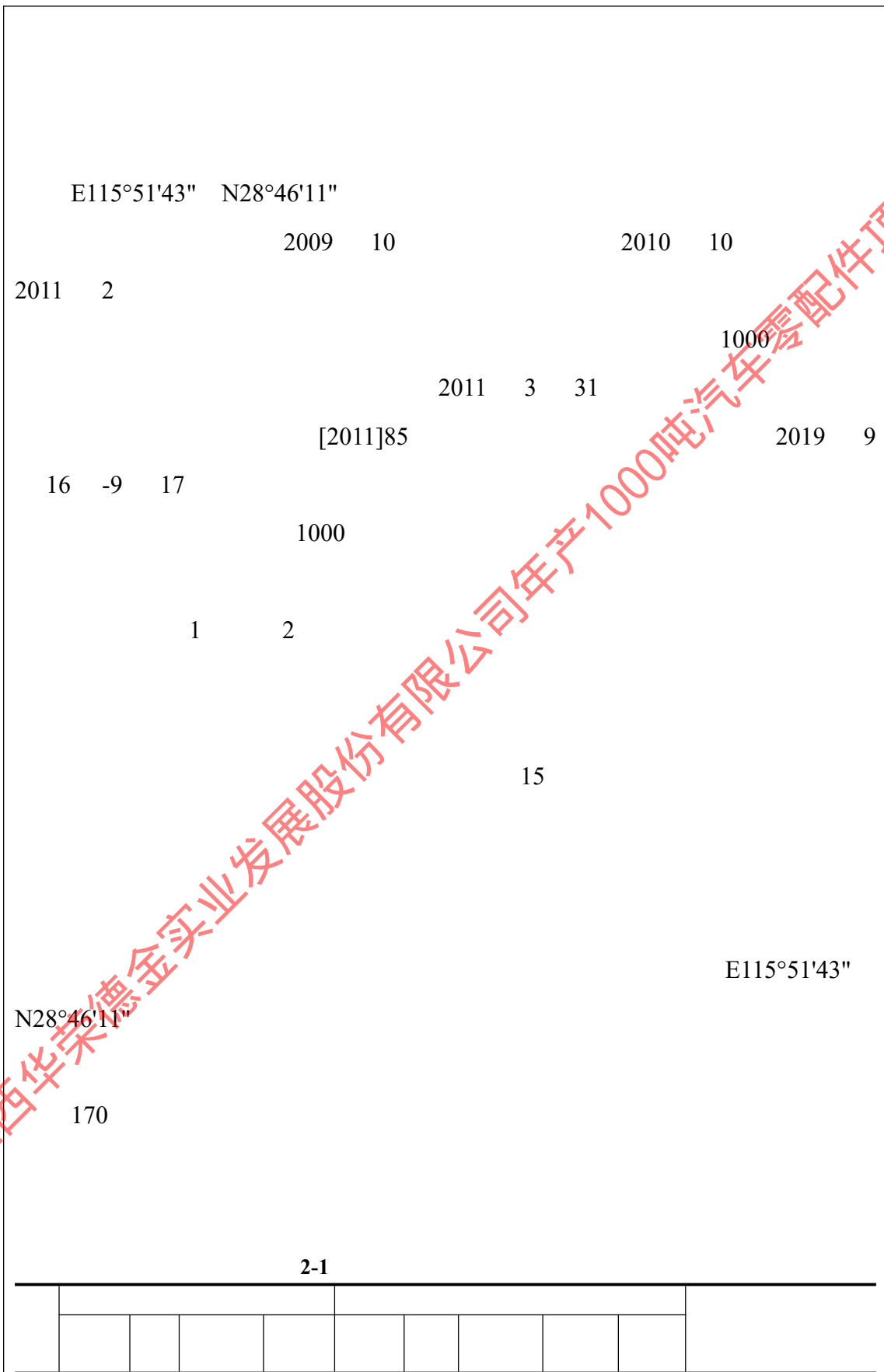

			50	2	/	/	/	/		GB3096-2008 2
										GB3095-2012
	/	/	/	/			170	500	/	
	/	/	/	/			510	600	/	GB3095-2012
9540				4318				9.5		500
2-2				2-3			2-4			2-5
				2-2						
			1	2			1		2	
				15						
					+					
				15				+15		

仅限江西华荣德金实业发展股份有限公司年产1000吨汽车零部件项目公示

仅限江西华荣德金实业发展股份有限公司年产1000吨汽车零部件项目公示

2-3				
2-3				
			2	
		1400m ²	1400m ²	12
		12		
2		2400m ²	2400m ²	12
		12		/
		518m ²	518m ²	12
		12		/
2-4				
2-4				

1				1	0	-1
2				6	0	-6
3				3	0	-3
4				1	0	-1
5			JNTE-4DHP-30AN	1	1	0
6			QM7836-4C	2	0	-2
7			RSB-2016-138-04	1	0	-1
8			-	1	0	-1
9			HGR1700	1	1	0
10			1800	1	1	0
11			HKD-14420STGF	1	1	0

2-5

2-5

1		5	2
2		8	4
3		1.5	1
4		5	2
5		0.5	0.5
6		20	9.5

2-6

2-6

1					/
2		/	1000	1000	
3					
4		/	1.6	0	0
5	46#	/	200	0	0
6		kg/	160	0	0
7		/	7000	280	-6720
8		/	24	24	0

46#

2-2

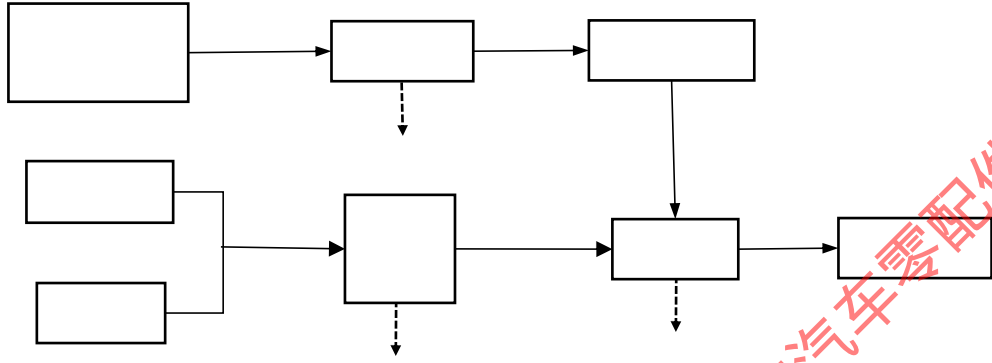

2-2

1

2

3

4

2-7

2-7

仅限江西华荣德金实业发展股份有限公司年产1000吨汽车零部件项目公示

			pH COD BOD ₅ SS NH ₃ -N	

2-8

	C3725	C3670	
	1000	1000	

仅限江西华荣德金实业发展股份有限公司年产1000吨汽车零部件项目公示

3.1

1

3-1

3-1

		PH COD _{Cr} BOD ₅ SS NH ₃ -N		

3-1

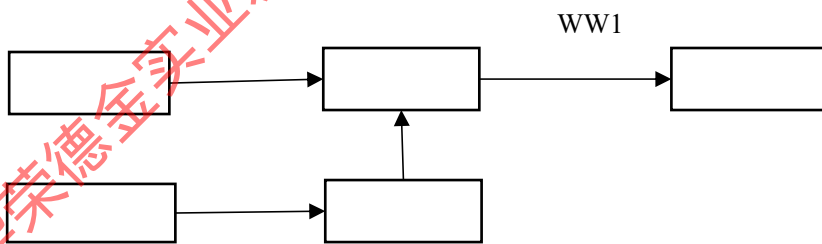

3-1

仅限江西华莱德金实业发展股份有限公司年产1000吨汽车零部件项目公示



2

+15

15

+



3-3

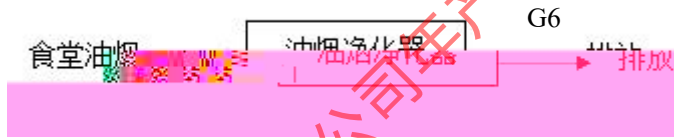

3-

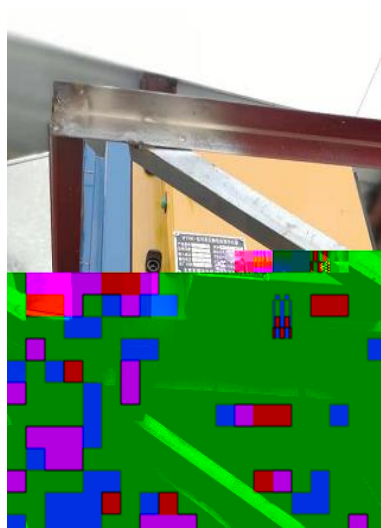

仅限江西华荣德金实业发展股份有限公司年产1000吨汽车配件项目公示



3

3-3

3-3

仅限江西华荣德金实业发展股份有限公司年产1000吨汽车零配件项目公示

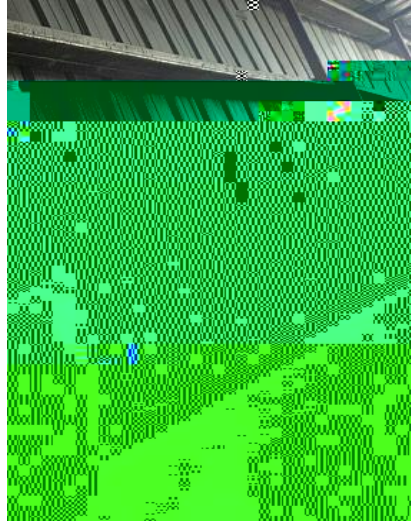

4

3t/a

0.5t/a
3-4

		/a		
1		3		
2		0.5		
3		0.05		

仅限江西华荣德金实业发展股份有限公司年产1000吨汽车零部件项目公示



3-5

3-5

	()			
		PH COD _{Cr} BOD ₅ SS NH ₃ -N		
			+15	GB16297-1996)
				GB18483-2001 2

3.2





仅限江西华荣德金实业发展股份有限公司年产1000吨汽车配件项目公示

4.1
1
1998 2002 2002
10 500 7
1000 1000 200
15 518 105
28°46'36.75" 115°51'39.28"
2
(1) GB3095-1996
(2)
(3) GB3838-2002 IV 2
3 2005
4
5

1

46#

15

1000mg/m³

+

95%

15m

50mg/m³

3100m³/h,

1.24t/d

0.434t/a

2



240t/a

GB/T18920-2002

7

1

2

4.2

2006 12 15

[206]47

9540

4318

□ 500

□d



2

1

“ ”

1

2

3

仅限江西华荣德金实业发展股份有限公司年产1000吨汽车零配件项目公示

仅限江西华荣德金实业发展股份有限公司年产1000吨汽车零部件项目公示

15

+

15

1

“

”

2

“

”

3

GB18597-2001

GB18599-2001

“

”

“

”

)

3

GB8978-1996

-

GB/T18920-2002

GB8978-196 4

CB16297-1996 2

GB18483-2001

+

15

+15

仅限江西华荣德金实业发展股份有限公司年产1000吨汽车零配件项目公示

5-1

	pH	pH GB 6920-86	/	pH / FE28Standard/ YQ023
		HJ 535-2009	0.025mg/L	/T6 /YQ148
		(BOD ₅) HJ 505-2009	0.5mg/L	/ SPX-150B-Z/ YQ144
		HJ 828-2017	4 mg/L	/
		HJ 637-2018	0.06mg/L	/JC-0IL-6/YQ037
		GB 11901-89	4mg/L	/Cp214/YQ013
	A	GB 12348-2008	/	/AWA6228+/YQ091
		GB/T 16157-1996	20 mg/m ³	/
		,GB/T 15432-1995 2018 31	0.001 mg/m ³	Cp214/YQ013
		(A) ,GB 18483-2001	/JC-0IL-6/Y Q037	0.1 mg/m ³

仅限江西华荣德金实业发展股份有限公司年产1000吨汽车配件项目公示

仅限江西华荣德金实业发展股份有限公司年产1000吨汽车配件项目公示

10%

0.5dB A

25

6.1					
1					
6-1					
WW1			pH SS BOD ₅ COD _{cr} NH ₃ -N		2 4
6.2					
6.2.1					
1					
6-2					
6-2					
		°C	kPa		m/s
09	16	31.3	100.12		2.1
09	17	32.3	100.60		2.2
2					
1					
3					
1					
4					
6-3					
G1					2 4
G2					2 4
G3					2 4
G4					2 4
6.2.2					
15					

仅限江西华荣德金实业发展股份有限公司年产1000吨汽车配件项目公示

1		2	
6-4			
6-4			
G5		2	3
G6		2	1 5

6.3

1			
4			
6-5			
N1	1		2
N2	1		
N3	1		
N4	1		

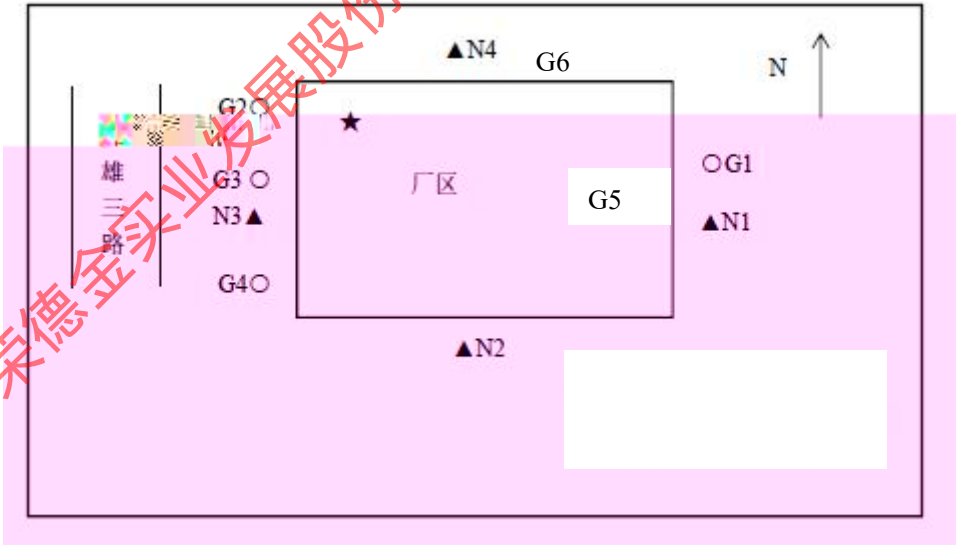

6-1

仅限江西华荣德金铜业发展股份有限公司年产1000吨汽车零配件项目公示

7.1

7-1

		(t/a)	(t/a)	%
2019.9.16		3.33	2.50	75.1
2019.9.17		3.33	2.51	75.4

7.2

7.2.1.1

7-2

7-2

L

			1	2	3	4		
2019 9 16	WW1	pH	6.93	6.91	6.98	6.88	6.88-6.98	6-9
			30.8	33.9	32.4	35.3	33.1	400
			8.7	9.2	10.5	9.6	9.5	250
			11.8	11.4	11.0	11.8	11.5	30
			8	8	7	8	8	250
			0.14	0.11	0.08	0.07	0.1	10
2019 9 17	WW1	pH	6.88	6.89	6.90	6.85	6.85-6.90	6-9
			34.7	32.4	31.0	33.0	32.8	400
			10.7	9.4	10.4	8.1	9.7	250
			11.0	11.2	11.7	10.9	11.2	30
			8	7	8	8	8	250
			0.14	0.07	0.16	0.08	0.11	10

7-2

pH CODcr BOD₅ NH₃-N

SS

GB8978-1996

4

7.2.1.2

7-3

7-3

/ 3

			1	2	3	4		
2019 9 16	G1		0.084	0.050	0.067	0.084	0.084	1.0
	G2		0.134	0.117	0.150	0.117	0.150	1.0
	G3		0.100	0.134	0.117	0.150	0.150	1.0
	G4		0.134	0.117	0.150	0.167	0.167	1.0
2019 9 17	G1		0.084	0.067	0.084	0.067	0.084	1.0
	G2		0.134	0.150	0.117	0.134	0.150	1.0
	G3		0.117	0.134	0.150	0.134	0.150	1.0
	G4		0.117	0.150	0.167	0.134	0.167	1.0

7-3

0.167mg/m³

GB 16297—1996 2

7-4

7-4

			1	2	3			
09 16		m ³ /h	2150	2081	2123	2118	/	/
		(mg/m ³)	24	27	25	25	120	
		kg/h	0.0516	0.0562	0.0531	0.0536	3.5	
G5 09		m ³ /h	2144	2209	2170	2174	/	/
			23	26	25	25	120	

	17	(mg/m ³)						
		kg/h	0.0493	0.0574	0.0542	0.0536	3.5	
7-4							2	
120mg/m ³		GB16297-1996					2	
7-5		/ 3						
				m ³ /h	mg/m ³	mg/m ³		
G6	9 16		1	6071	0.15	0.5	2.0	
			2	6894	1.05			
			3	6435	0.36			
			4	6839	0.34			
			5	7022	0.33			
	9 17		1	5961	0.77	0.7	2.0	
			2	6675	1.03			
			3	7100	0.06			
			4	6760	0.43			
			5	6065	0.74			
7-5							2.0mg/m ³	
7.2.1.3		GB18483-2001						
7-6		dB						
09 16		2.1m/s		09 17		2.2m/s		
			09 16	09 17				
	1		55.7	55.8	60			
	N1		44.6	44.7	50			
	1		56.4	54.4	60			
	N2		45.4	45.2	50			
	1		57.0	56.3	60			
	N3		45.8	45.0	50			
	1		55.0	54.8	60			
	N4		44.6	44.6	50			
7-6								

7.2.1.4

t/a

0.5t/a)

0.05t/a

仅限江西华荣德金实业发展股份有限公司年产1000吨汽车零部件项目公示

8.1.1

pH CODcr BOD₅ SS NH₃-N

GB8978-1996 4

8.1.2

GB16297-1996 2

GB18483-2001

GB16297-1996 2

8.1.3

仅限江西华荣德金实业发展股份有限公司年产1000吨汽车配件项目公示

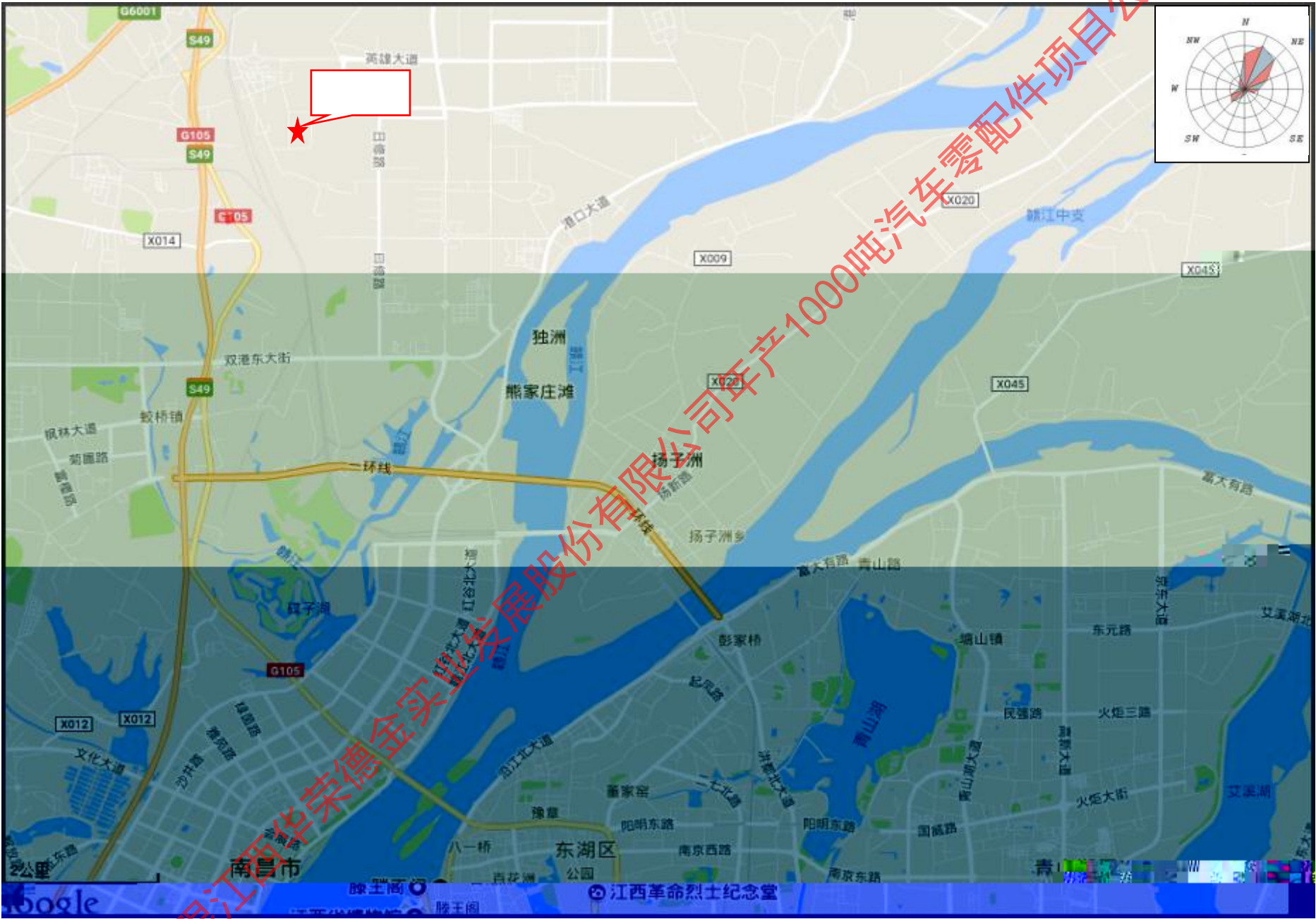
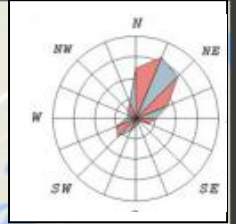

D

D



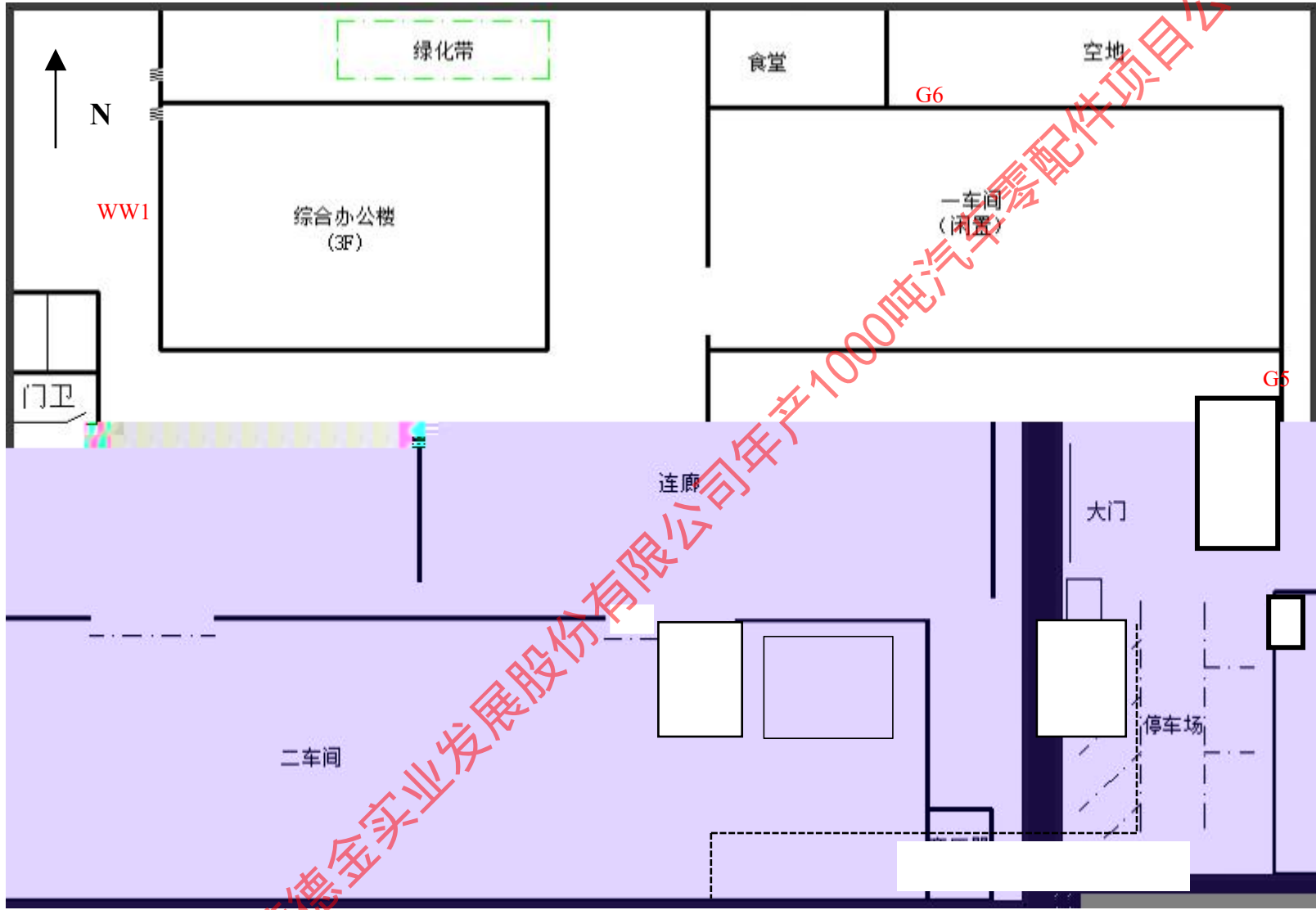

仅限江西华荣德金实业发展股份有限公司年产1000吨汽车配件项目公示

仅限江西华荣德金实业发展股份有限公司年产1000吨汽车配件项目公示