

# 目 录

P..f N'- † å

N'- † å

P..f +a

P..f 0 ı å

P..f ~

P..f -( £# » ^ # ?ô ^ ?ô1 ..?ô93

P..f ° \_?ô93

f -( £ • &

O; \*Aî ı å

' \*6 }5 œ£M 35

\*Aî µ Ø

k?- ~ Eµ É œó É

"d\$Àœd £>

N'- +Ox 8"#ç;1°F

N'- Øı å

)ß † ÔAî í

" ( "°\*6 45 Aî í

f )ß † ÔAî í

)ß Aî í ~ Ct œ 9 < & :m , ı å

\*AîN'- )ßAô Ôz k?-5 ACE> \*AßœÑ' G L Ñ' a °

\*AîN'- )ßAô Ôz , k?-5 ACE> \*Aß

Ñ' G L Ñ' a °

P..f >| 7 ö

" ( ´ n 7 ö

)ß † CXÿ 7 ö

\* ~

P..f - #{ µ Ø

)ß † ÔAî í Bß x ì

)ß † CXÿ- #{

N-OL  
ESFIOYMBG  
POISITNS 1 · 2N T (~ÿ gpe  
jvÿy N g ÿ Qiy:

- #{ &

CXGy Aæ.CXGy x f

- #{ 6 Å Ø#

Æ CtCX

- #{ 6 ÅE÷0; ], CXGy Aæ.CXGy x f

P..f- #{5 Ì

+Ox å

)ß ‡ ÔÂî í Bß x Ì

O; \*Aî ))ß ‡; i ý

G??ab3 5 Ì

P..f- #{5 AÆ..\*AP

N'- † å

)ß ‡ ÔÂî í Bß x Ì

O; ))ß ‡; i ý

P..f 5 AÆæ\*AP

Lt .

Lt . N'- ' \*6 } 5 .

Lt . N'- O&Ø6 3 .

Lt . N'- £M 35 .

Lt . " "d 4\*6 †4<sup>an</sup> 93\$ .

Lt . N'- EØ1 J 6 3 .

Lt . N'- > O •; £3+

Lt . ' ; "d- #{&Ø} .

Lt . O - #{ 3&Ø.

Lt . N'- ~"d ^ ~"D ... 3&Ø.

Lt . M" 1Ñ5 .

Lt . 1 J1Ñ6 f Ö

Lt &

Lt &

Lt & N'- 7 xFJ.

N-01-ISTIOYÑg PQIS^tNS 1 . 2N T(~ÿ gpe jvÿN g ÿ Qiy:

Lt & kGÿ x f 7 7  
 Lt & )ßAô' =  
 Lt & † oO Cq8 <  
 Lt & † oP..f Ñ' >  
 Lt & åAæ>  
 Lt & O- )ß † » & ~ UN· x 7 x • &  
 Lt & ~ A722„ 45 Aß  
 Lt & ð#{ Õ z  
 Lt & j ~ Aß  
 Lt & " "d4<sup>a1</sup>Ñæ>  
 Lt & ~ +eD fl \* i å  
 Lt & :U J '  
 Lt & #{5 Õ z  
 Lt & GB3 >  
 Lt & P..f 6 OB\$>  
 Lt & £ ¼~ A722„F † n ß j • &  
 Lt & ' MLb\$Gí 8 <  
 Lt & F E^ Aß  
 Lt & ' " AŁ Aæ  
 Lt & P..f ??æ  
 f MØ-B\$>: »IV  
 9 < &« Aæ

N-OL  
 ISFIOLYNB G PQIS^TNS 7 2N TC~Y gPe JvÿN g ÿ QIy:



P..f N'- t á

N'- t á

N'- t á?æ ~

> N'- t á>

*AîN'- =0	/ x 7 X5 5H ÉN'- ~ 0 0 ~		
*Aî } =0	" ?f=‰)β 0 ° 9L (		
*AîN'- VCX	à *		
*Aî ' &Ø	" ?f-1 < 2\$fgüj 5 ÝKwy ~ 5 Ý J ~		
AîÑ-Ox7- ,	/ xK 2, 7 X		
P..f 93\$ > µ Ø	\IQP..f 93\$ j / x 7 X5 5H ÉN'- ~ 0 0 ~ ~ +eD fl f %O4*6 +Ox4i		
)BAô Ö z 5Ff }	! c 2 ' /)β 0 ° 9L (	)BAô Ö z 5Ff ...@ &L\$	/ 8
)BAô Ñ ' G L	< 2)β † Ô p	)BAô Ñ ' &L\$ > • ' #Z)β Ñ ' ,	/ 8
O &L\$	/ 8	1 &L\$	/ 8
)à j - #{ &L\$	/ 8 8 8 8	" AŁ AædN¶i á	" 4ÿ+dN¶

P..f +a

\N'- k ~ Ct 7 s ÆA 1 ~ O +X ~ \_L¶+e\$Àt t oF >|+Ox ~ O +Xt  
o k ' MO j É Ø2É" k \*1 MO 4Ö É Ø2É" f ]+OxE L\$ ^  
^ 1y+Ox W+XoMO j 4Ö É Ø2Éx5, 84Ö ^ O 2 œ 1yM+Ox W+XoMO  
4Ö 4Ö



í)ß † ÔAî í1 P..f œ( £- - 1Ñ\*6 ~" ?f|=‰)ß O ° 9L ( ¼  
/ 8 " É \*AîN'- )ß † Ô1Ñ\*6 » ° ~ AÔ\ -?-"r 4ô4÷¶P..f  
4ô" O B8 kF >| \*AîN'- 1 )ß † ÔP..f ~

P..f O i á

/ 8" ?f|=‰)ß O ° 9L ( i N'- )ß † j ýAô' • & œÑ  
' • & ) 4)ß Aî í 1y| áF >| ¶8 " f ) 8 ] )à, L N'F >| / i ~ i  
É \*AîN'- 1 )ß † ÔP..f † >| , # ° ~ -)ß?ô)ßAô  
> ¼ / 8 " ?f|=‰)ß O ° 9L ( F >|)à j P..f- #{ ~  
?æ&t & " " ?f|=‰)ß O ° 9L ( ¼ 8#  
8# )N'- F >|G÷g 6 À ~

i ð#{ Ôz œ\N'- 4)ß Aî í F >|1y| á " 84ô4÷5F f ¶  
É" ?f|=‰)ß O ° 9L ( / x 7 X5 5H ÉN'- ~ O O ~ 1 )ß †  
ÔP..f- #{ Ôz ° " f4ô4÷P..f 4ôF >| Ñ ~  
\IQP..f j / x 7 X5 5H ÉN'- ~ O O ~ " ~ +eD fl %tO— 4  
\*6 ü ü+Ox4i 7 ~ A72, ^ 9 j A72« ( 45 Y+Xü ü+Ox4i 8 ... )ß"WA  
72\* — ü ü+Ox4i 9 = X \IQP..f 93\$ { µ ~ " / 4\*6 ~ g+eD fl4Ö  
X " +OxK 2, 7 X ~ P..f µ Ø 5 +OxE L\$ œ ~ +eD fl %tO—  
4\*6+Ox4iG} Aî 7 " +OxE L\$ " 5, 8 < " O 21y ~

2N T C Y gpe jviyN g y Qiy:  
istfioýñb g PQISVINS

N O L

P..I

P f

~ - É ] ~ CEA j ...-)B ‡ O#

8

/ 8

í x

~ - É ] ~ CEA j ...-)B ‡ " Lb"° # ° " / 8



O; \*Aî | å

' \*6}5 œ£M 35

' \*6}5

5 Ý J } ¼ < 2?fl GFœ" D < 2 Gü" ' 4 < JC œ" 6<  
 < JC œ\_" ?fl-1 W] » J fFP 1 J O j Lö] ^ J FO; Ö OQ, ' j  
 ~ LF° - æ4x0 j <4ÿ#~° \_0 j " GM-14x0 j " ?fl #S4ÿ#~  
 ° \_0 j " j } Hï > n ~ f ] " 5 Ý J O O } ¾ 5 ÝKwkwj G" ?ð  
 B93\$ C\$ „ O4x D " L d" ?fl #S4ÿ#~0 j " ?fl8# < ° 6 J  
 L " G8#5 ÝKw| o1Ñ\*6+|L " ?ð B kMO E Ø Gü" ° } j 5, 8 W  
 J j " \*p fFPJ j k " k , x J j j à fFPJ ^ 40 ÷ J . F fFPJ ~  
 " ?fl=‰)ß O ° 9L ( ) ¾ \$fGüj 5 ÝKwy ~ 5 Ý J " " '   
 \*6 7 ÖL4ÿ " G4Ü " N' L x j O" " " ?fl x j  
 " ?fl O •)ß 9L ( " x j "ø F# ( " G x j + ' ' ~ \!QP..fN'- ZAî  
 5 +Qb ÔD /° ~ +OxE L\$Aî5 +Qb ÔD /° = X \!QP..f93\$ {  
 µ " B3 5 ì n/j " \N'- EØ 93\$ µ O æ2«1 J ^ Q ^ k  
 L ^ u"A j 1y)ß ‡ O&Ø" D /°N'- OF ; O&Øj ?fl G Ø A ; 7 æ"  
 =) \N'- . @f4Ö 3P~ B N'- † j ' \*6}5 . ?æt . " EØ O&Ø. ?æ  
 Lt . " £M 35 . ?æt

> k?)ß ‡ Ô)B œ 7

i ý 3P	¿	Ô)B	Ø } D /°	?ð Q	Ô) B	Ø } D /°	?ð Q	F i å	)ß ‡ ~ 7-
WD)ß ‡ ~ )ß ‡		æ	?fl G	4Ö	7 æ	?fl G	4Ö	=	] ..4x7 ö
	x K;	L%æ	?fl G	4Ö	x K;	L%æ	?fl G	=	
		F^ æ	G	4Ö	F^ æ	G	4Ö	=	
	xK; E & L	L		4Ö	xK; E & L	L	4Ö	=	
	y / æ			4Ö	y / æ		4Ö	=	
	H æ			4Ö	H æ		4Ö	=	
	5 ÝKw	?fl		4Ö	5 ÝKw	?fl	4Ö	=	

NOL

istioyng poistns 2NTC y gpe jvyn g y Qly:



					œ				œ		
	5 Ý	O 4ô	?fl G		4Ö œ	5 Ý	O 4ô	?fl G	4Ö œ	=	
		~ æ	?fl		4Ö œ		~ æ	?fl	4Ö œ	=	
"d)ß ‡	% "a		G			% "a	G			=	] 2«"d 7 ö
' ; "d )ß ‡	j ' ; "d				j ' ; "d					=	] 2« "dCX7 ö

EM 35

\N'- k ' É Ø2E" k \*1 MO j É Ø2E" N' \*Ai 9 ;  
 Or, +OxE L\$MO wj ^ ; ~ r, 5, 8 < \*1 MO j ^ ; O  
 r, O 2 \*1 MO j ~ \IQP..f µ Ø5 +OxE L\$ œ ~ +eD fl %tO—  
 4\*6+Ox4i œfG} Ai 7 " +OxE L\$ " 5, 8 < " O 21y " +OxE L\$ = X \  
 IQP..f 93\$ { µ ~ ^ ^ E L\$ } ¾' " +aL ° ?fl Ø A " IQ j E  
 L\$ ^ E L\$ ^ E L\$ " O 2 ... < } ¾N'- L G x ~ j ¶ i ¾ E " \N'-  
 6 +Ox t oAi5 j ~ É ...@æ ^ " } ¾' ?fEØ ~ +a¾ \N'- +Ox4i 7.d  
 ¾Ai 7 \$Æ±Q " j ¶Ffl} f ) EØ " A, j ý " \N'- 6+Ox4i 7Ai5 X  
 +OxE L\$ " < & X +OxE L\$Ai5 9 ~ É d & Ø j ~ j ¶ 8\*6 45 N'- , \*  
 ~ ( " N'- X +OxE L\$Ai5 9 j L ~ ( t L\$ ... ~ A722, nj ~

N-OL isfio ýň g POKSATS 1. 2N LC ě gpe jviyM g ý Qiy:

\*Aî µ Ø

N'- \* \ i å

\N'- k ^ Ct 7 s ÆA 1 " O +X ^ \_L¶+e\$Åt t oF >|+Ox " O +Xt  
 o k ' MO j É Ø2É" k \*1 MO 4Ö É Ø2É" f ] +OxE L\$ ^  
 ^ 1y+Ox W+XoMO j É Ø2Éx5, 8 < ^ O 2 œ 1yM+Ox W+XoMO  
 4Ö É Ø2É" \!QP..f 93\$ j " ?f=‰)ß O ° 9L ( / x 7 X5 5H  
 ÉN'- ~ O O ^ œfG} Aî í ~ \N'- 6| k Æ j Æ" f Ö j  
 ? & 9\* +Ox f " /+Ox Y ~

x æØ x

\N'- k?- x æØ x?æ ~

> x æØ x

¿ ' ^	x æ=0	}	)BAôAîAÑ/ x Gy	Lu xGy	7 #
	K 2,	7	4Ö	4Ö	
	5 5H É	7	4Ö		= X \!QP... f 93\$

N'- O;4ô

> )BAô œ' =Lflâ "Aî µ Ø > , Lu \*Aî µ Ø O?i >

N'-	*Aî =0	?ô Q œµ Ø	\!QP..f µ Ø	F i å
k O;	+OxE L\$	N'- +Ox4i 7 ~ ^+eD \E L\$k?- j +Ox4i 7 ~ ^+eD fl %oO— 4*6 ~ ¿ = Ñ " +O x4i 7 ~ ^+eD fl %oO— 4 *6 ~ G÷X; _ O ~+eD fl W» ¢ ?+Ox4i " j O FAî 7 " +O xE÷0; X öL 3+5 ]F >  " 3+ 5 [L H3+5	\E L\$k?- j ~+eD fl %oO — 4*6+Ox 4i " G÷X; _ O ~+eD fl W» ¢ ?+Ox 4i " j O F Aî 7 " +OxE÷ O; öL " 3+5 [L H3+5	>)BAô O8\$
	+OxE L\$	N'- +Ox4i 8 A72, ^ 9 j A 72« ~ ( 45 Y+X ..+Ox4i 9 ~ ~)ß"WA72* — " +X< O Aî 7F > +Ox " } ¾ E L\$	= X \!QP..f 93\$	= X \!QP... f 93\$
Eµ Û O;	+OxE L\$	N'- ~ É œ@æ Ø j	N'- ~ É ^ @æ Ø j œ j ~ t j	>)BAô O8\$
	5, 8 <	N'- . œi 8=j	N'- . œi 8=j	>)BAô O8\$
	O 2	Ø o œ O@µ	Ø o œ O@ µ	>)BAô O8\$

N-OL isfioýng POISINIS 1 2N T K ý gpe jviýN g ý Qiy;

+X O;	5 "d3+5	2 o5 "d	2 o5 "d	>)BAô 08\$
	^"d3+5	M" 6#qf	M" 6#qf	>)BAô 08\$
	, +e3+5	2 o , +e	2 o , +e	>)BAô 08\$
	+ej o	} ¾N'- +OxE L\$	\N'- ZAî5 +ej	\N'- ZAî 5 +ej
)B O;	F2Ú	Z " } ¾N'- 5, 8 < L x	Z "N'- 5, 8 < L x	>)BAô 08\$
	BNp 3>>? Lö H	} ¾ +OxE L\$ " BNp 3 >>L HAî 7 " 2, H "D4ÿ Q "D1 " n " "D1 "	} ¾ +Ox E L\$ " B Np 3>>L H Aî 7 " "D4ÿ BNp 3>>L HAî 7 >4ÿ i 2fQ "D1 " n	j 1(A) )B+ " "N'- Aî5 L HAî 7 " 63 < ' Lu "D1 8 f Lî " \N'- "D4ÿ i 2E "D1 F "
	M+b' k&ó fLö 45 3+5	4ÿLöNp5 fLö>+a#k W&ÝhLt 4 *6 " { >%bJE÷ Q "D1 h " "D1 "	= X \IQP..f 93\$	= X \IQP... f 93\$
i " t "	N'- " 5>  f ^ " #k W&Ýy d & Ø " } ¾ +OxE L\$	N'- " 5> ( œ " 3>>fLö X i " t ^ " O Ô+a" ?fl L" )B ( ) 4*6 45 " " A72, " [L H fLö2, H Lö] fLö > " ?fl'h <( ) #q 9L (F °TÖ ‡ n B j B	" A72, 4 5 ° A +O F x+Oÿ = " 4ÿ- )B GL < ? " \$ ?æt & - " ?fl'h <( #q 9L (F °TÖ ‡ n B j B	

N-OL isfioýñb g POISIAVS 1.2N TC VOPD VÿN g ý QIY:



† j)à j' (w



+OxE L\$)à j' (w

N-01



.)à j' (v

N-01 isfio'lyñ g PQIS^tNs 7. 2N T(-y gPe JvÿN g y Qly:'

k?--+OxAî 7

N'- +OxAî 7B ?æ

> k?--+OxAî 7

+Ox4î 7Aî 7	¿ ' 7	Aî 7 =0	Gÿ	Lu í á	F í á
4îD fl .d.¾ 6F93+ 5		,p VE^F1 j			
		¾ j			
		? wj			
		Oß?.d.¾ j			
		.æF9E^F1 j			
		_ Ø1 F9 j			
		#Ñ+e#q 6F9 j			
		+eD fl C+X2„¾ j			
		4ö Ö 6 Å			
		BNp; É			
		BNp 3>»L H Aî 7			
		Q »M+e 6F9 j			

\ N'- 4îD fl 6F93+5 +Ox; x7+8N, k?- j +eD fl C+X2„¾ j " B Aî 7  
 Lu Gÿ >)BAô' = 08\$ " ! N'- x7- >)BAô' = & í á 08\$ ~ f Aî 7  
 † Ö ¾ j ^ ' ? wj ^ \_ Ø1 F9 j ^ #Ñ+e#q 6F9 j ..Q »M+e 6F9 j 1y .  
 Lu Gÿ >)BAô = 08\$ " k? \_+a¾ BAôLf!á " ) N'- : F Aî 7, N' ' = ö. ,  
 8\$ " v = j ý x7- ~ N'- )BAô' = j BNp 3>»L HAî 7 " Lu+OxE÷0;  
 ] " j fl ý A )B ð; " " — BNp 3>»L HAî 7 " LuL HAî 7 j  
 ~ ' BNp 3>»L HAî 7Aî5 X 4î"D#q 6F9 ¿ " ' BNp 3>»L HAî  
 7Aî5 X 4î" Gÿ 6F9 ¿ " ' BNp 3>»L HAî 7Aî5 X 4î"D#q 6F9  
 ¿ " ' BNp 3>»L HAî 7Aî5 X ..!Q.d.¾ ... 4î" Gÿ 6F9 ¿ ~+OxAî 7 ]  
 G 6Aî 7 >)BAô' =+ 9 ¿ ý " k?--+OxAî 7 \* \ 08\$ " = ¿ ->)B ð"

2N TC-ÿ gpe yvüN g ý Qiy:

NOL



一级破碎



OB? .d. %j



+eD fl C+X2, %j

№ 01

ИСТИКНИН Г. ДАШТАНСТАН ТУУЛГАЙ АЖААЛЧИЙН ГЭМЭГ



\_ Ø1 F9j



Q »M+e6F9j



4öÖ 6 Å

k?- ~Eμ É

> N'- ~Eμ É / +XGÿ

¿'	=0	)BAδ+XGÿ	Lu+XGÿ	\$Å
O ^ ~Eμ É#,6G				



	g+eD fl	4Ö	4Ö	FC]
	"d			2 o
	+e		7 Ö	2 o

> ( É £ > >

E <sup>-</sup>		E <sup>-*</sup>	
=0	( É Gy	=0	( É Gy
3 g+eD fl		K 2,	
		A72, [ L	
		HAÎ 72, H	
		F 2,	
		f	
8AÑ		8AÑ	

7# Ö j x aK 2,, x+ÖGy a ¾~ É, @ 6 " D ~ É @ 6 4 9 2 " u \!Q à 9 ~  
+eD fl 45 GyAÑ h1 ~

i " ?fl=%ö)ß 0 ° 9L ( ,; ~ +eD fl Ö fE 06 " 8 /  
88# / 8 j 45 ~ +eD fl " +OxK 2, " F 2, H  
" f ~ 5>I( ... - ~

"d\$Acéd £>  
N'- +X'd 8 j "d t , "d "N'- +Ox "d " +X'd 5 6| +G#k+X'd ^  
O 2+X'd ..5/F+X'd ~ i )à j B3 ...6 Å "N'- 6| +G#k+X'd4Öj  
O 2+X'd4Öj " 5/F+X'd4Ö " 8AÑàRì+X'd ~ ~ "d x+O  
Gyj ~ \N'- F >|, "dGy£> . ?æ. ~

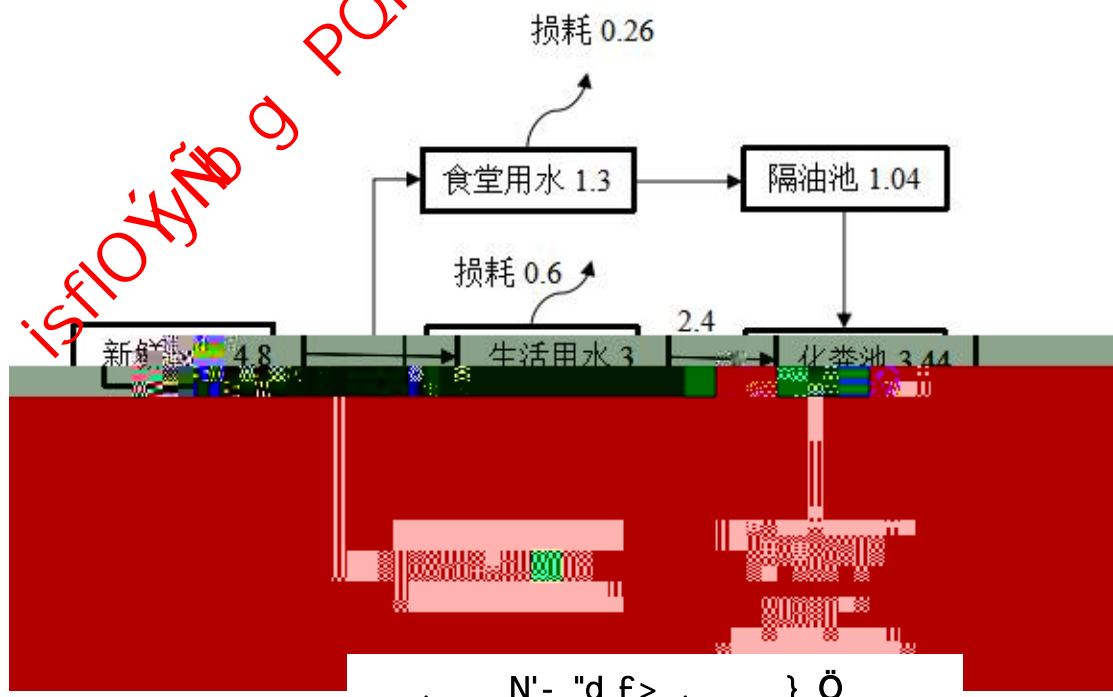

N'- "d £> . } Ö

N'- +Ox 8"#q;1°F

i ~ É ...x æ= < " \N'- 6j 9/y+Ox 8" Ö~ +eD fl %bO— 4  
\*6 ü ü+Ox4i 7 ^ A72,, ^ 9j A72«~ ( 45 Y+Xü ü+Ox4i 8 ...~)ß"WA  
72\* — ü ü+Ox4i 9 ~ \!QP..f j / x 7 X5 5H ÉN'- ~ 0 0 ~  
P..f μ Øj Ö~ +eD fl %bO— 4\*6 ü ü+Ox4i 7 ~ / x x æK 2,, 7 X  
~ 9j A72«~ ( 45 Y+Xü ü+Ox4i 8 ...~)ß"WA72\* — ü ü+Ox4i 9  
= X \!QP..f 93\$ { μ ~ ~ ~ +eD fl %bO— 4\*6 ü ü+Ox4i 7 8"#q;?æ;

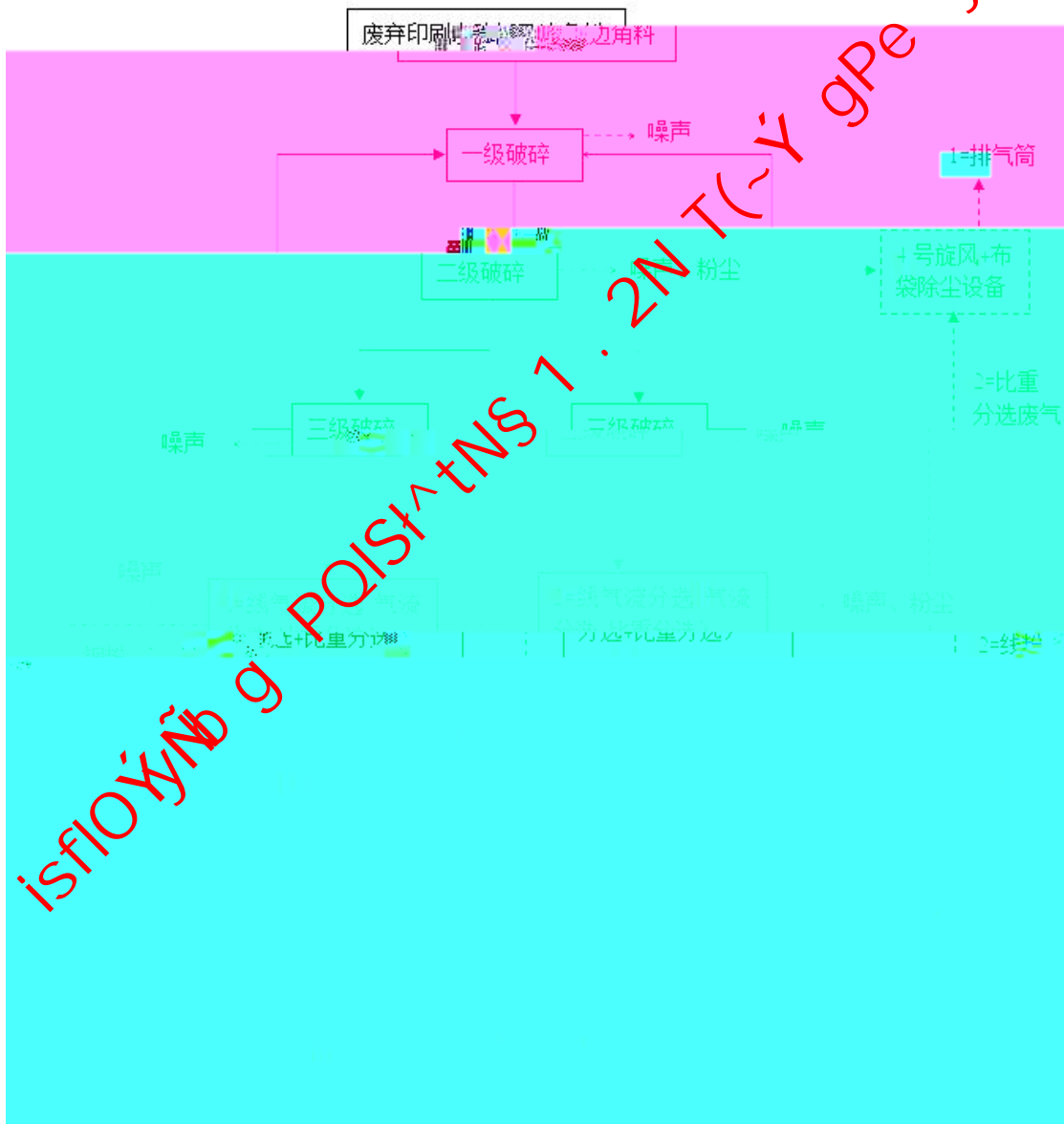

istioýñb g poistns 1 2N TC~y gpe jviñN g ý Qiy;

N-O I-

. ~ +eD fl %bO— 4\*6 ü ü+Ox4i 7 8"#q;  
J, ) ~ +eD fl ^?¶K fl ^EØ@ É: (' &Ø' \N'- ~ +eD fl %bO— 4\*6G÷  
94x2,,¾ ^ 94x6F9 8" ~ fl f 6 [ %bO@j f Y+X· H 2,, [ ...A72

40\$ [ ~ O ~ l e D f l E ..4x2'.d.¾ " 6( É.d.¾ @ # W  
? " F 1\ 94x2,,¾ " fl f @j 2,, [(æ H ^ A  
724 6F9 ..M+e 6F9 " 6H @ 6 > A726 0 " .  
÷0; ], 2,, H" " X ..!Q.d.¾ ..Np, 6F9  
9 x ' @ ^ ¶2,, H ..!Q" ~

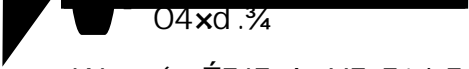

04xd.¾  
W ; ( ÉFJE÷,P VE^F1j F .d.¾j ".d.¾j 6 W ; ~ É^-¾8#  
2' ., ? ~  
~ " ..4xd.¾

4ÿ04xd.¾ > ^ @? ; ( ÉFJE÷,P VE^F1j wO w8#OB?2,,¾j F É  
F >| ..4xd.¾ " OB?2,,¾j 6 ? ( ÉF O! 2,,¾8# 2' . ~



4ÿ ..4xd.¾, ( ÉFJE÷,P VE^F1j E^F18#+eD a0C2"¾P 8u e \$ Kæ @ æ01042" P '

a o b l

M+e6F9\_ Y+X= <( É XQ »+ej μ, +eW 26-Éî ' 6F9 , , O/ý  
 6F9Ø# ~ ( É4ÿBE -p, UCl V8#e +e- ... - +X: Q »+ej ] & "   
 ( É ' 4/ý+e, ~ 5 ^ , ^ M+ej +X, œ|M h E , - ^ /° ó , ^ Gy   
 , , +X~ +a¾4/ý( É V+eWCX= < " , (æ1, = < fl( É:m; &, E F)   
 = < " p6-Éî ' 6F9, - , ~ K 2, ...A72,, 6 [ FJE±E^F1 j E^F1 ' = < \* É   
 5 ~

**x" )B8† 6 À Ö**

~ - ~ "D Ö \N'- j F 5 +Ox4î " +OxE±0; ] , 2, H4ÿBNp 3>»L H   
 6 [ 4ÿ ... "D1 í n ~   
 ~ - ~ "d ÖN'- ~ "d k?- j +G#k ~ "d ..O 20@ ~ "d   
 ~ - Ö \N'- j +OxAî 7+OxE±0; ] , j à   
 ~ - \* ~ Ö \N'- \* ~ k?- j +G#k ‡ n ^ L HAî 7 x+Q ~ 3>» ^ 5   
 >I x+Q ~ 5>I( ^ 6F9 x+Q ~ A72,, œ HAî í fLö, 2, H ~   
 N'- X+OxE±0; ] J x+O ~ "d ^ ~ "D ^ ... \* ~ " § ?æ; > ~

=0	"	x+O ¿	4*6 Ú í
~ "D	2, H ^ K œf F 8( ^ K&œ f F 8( ^ Ji œf F 8( K<œf F 8( ^ KOœf F 8 ( ^ K} œf F 8( ~	+OxE±0;	BNp 3>» 2É' "D1
~ "d	Gÿ4â ^ "X" ~ ^ Ø=( "Ø	+G#k	L~"Ø" ^ F2Ú
	1y x 4x	+OxE±0;	8*6 3 p ^ F9+X ~ Aî 7 ^ L~
* ~	+G#k ‡ n ^ ~ A72,, ~ [ L HAî 7 fLö, 2, H ~ ^ ~ 3 >> ... ~ 5>I(	+OxE±0; ... +G#k	+G#k ‡ n Ô+a)ß G L 4*6 ^ i Lt & #Z)ß * ~ ~ - ' • & œ * ~ ] ó, ' = μ Ø ~ ~ A72,, ~ [ L HAî 7 fLö, 2, H ~ Lö ] fLö >+a' ?ff'h <( #q 9L ( F °TÖ ‡ n Bj ß ^ ~ 3>» ...5>I >> Ô+a 9CtCX }" ?fl L" )ß 9L ( 4*6

N-OL isfioýnb g poistins 2NTLY gpe jvüN g ý Qiy:

N'- Ø | á

N'- Ø | á?æ ~

> N'- Ø | á O?† >

2« [ )βAô œ' =?-"r , Lu \*Aî | á Ø | á

VcX à \*N'- à \*N'-

?ô Q /+0x5 5H É 7 X ^  
K 2, 7 X / xK 2, 7 X

	<p>´Np" L} ~ 4ô4÷´ n ~"D          ) E L\$µ)ß †; i ý x : O          2"Ø ~ „&gt;i"Ø ð F &lt;Nf          ´ n ; +ej ~"D4ÿ ) ´          F ´ n ~ ´"D ~ F /° EØ          )ß † O&amp;Ø´ fQ ¾´ M          2E :</p>		
	<p>N'- ~ F9+X~ ; j àAî          7 ~ f 8*6 35 Q Aî          7 ~ ) x+O ; Aî 7G÷          ÿM7 #, ^L´ ^ hN#y          Úí ~ ÿ A ) EØß          †; i ý</p>	<p>N'- FJE÷ 8*6 3 pE L\$ ~ *          1 L´ ~ *p ÿ _ ~ —j          h5\$ÔAî 7 4 ¾8 &gt; ; F E          (æ11y Úí L)</p>	
	<p>~ 9' Ct\$ÄF ^ ÿGÿF ^          a F 45 ~ I ~ AÔO.m          42«* ~ fLö ^ 45 ..5,          8 Y+XÚí ~ U/- 6 42«+O          x´ ( ~ É-\$ Ô´ n F\$'          +Gk† n] n B´ i L´          ( ~ i L´ ( VCX; ~ É X          C'F 1Ñ*6E÷; ] ~ AÔO.m          -( E)ß † Ô?-"r ~ &gt; i          L´ ( E O+6 1y)ß          5 ~          ~ ( .d.¾ 5&gt;i&gt;» ~ 5&gt;  f ^          ~ #k W&amp;Ý ~ "Ø´ L HAî 7          ] \$ ; 3&gt;» ~ ¾ i L´          ( t ~ "Ø 9 i L´ ( 4          5 CtCX; } 4*6 x+Gk†          n fLö ) Ô+a)ß G L 4          ~ "Ffi} ..IQ" ~          ~ É ~ i L´ ( t          ~ 9 É i L´ ( C ^ "          x f 7 ö ~          ~ ?-"r *Aî ~</p>	<p>\N'- "Ø* ~ ( N«9 Ct          \$ÄF ^ ÿGÿF ... a F ~ I          62«4*6 ~ "4ÿAî5 j ~ t          j ~ N'- x+Q +Gk† n          n † n f fLö Ô+a)ß G          L \$5*6 x A72, ~ [L HAî          7 fLö2, H´ Lö] fLö &gt;          " ?f" h &lt;( #q 9L (F          °TÖ † n B j B x´          5&gt;i&gt;» ... 3&gt;» L" )ß          9L ( 4*6 45</p>	<p>\N'- G÷ 6          OP..f ~ \IQ          P..f µ Ø j ~          +eD fl %O—          4*6 ü ü+O          x4i 7 ~ »          f @»+Ox          4i ~ x+Q ~          A72, Lö] f          Lö &gt;+a' ?f" h          &lt;( #q 9L          (F °TÖ †          n B j B</p>
<p>~ ;          "d ...          O</p>	<p>) +Ox J j ~ É          i ~ t ^ 1y U I 9 É Ö z          ° œ( E ° _?ô93-"r G÷          Lb\$G ^ Lb7 Úí ~ Lb! N'          - F :U) O œ' ; "dFP@          "</p>	<p>+OxE L\$ ^ ~ É ~ i ~          t ~ " 4ÿG÷ Lb\$G ^ Lb7          Úí ~ f g)ß"WA72'          %6x † j Aî5 ' ; "d- #{ ~</p>	
<p>)ß †          Np          Lb93          Úí</p>	<p>N'- #, œ, ^ #, Lb1y Ø          M »N' ~ ÖB' ~ #, Lb1y          &gt;  o1Ñ*6G L Ñ' ~ f 9'          ~ #, Lb1y&gt;  o1Ñ*6G L          ; ?-"r F &gt; AîAÑ ^ *Aî ~</p>	<p>N'- ZAî5 \$"Ø +ej ~ =          #, œ\$"Ø Ø5 Np L N' ~ N'          - " 4ÿm .)BAô' = µ Ø ~          " f °O- )ß † » &amp; ~ UN·          x</p>	<p>\N'- ZAî5          7+X +ej</p>

N-O-L  
 ISTIOÝM G POISATNS  
 2N T(-Y GPE JvÿN g ý Qiy:

	<p>( ~ AÖÖ:m . É Ö z  ° ] * , 4N'NpL Lb93  Ú í " *OB... , » uN·Lb  Øx œ~ U 4*63+5 " -j  +Ox ^ F E ^ ^ C ^ E ÷ 0 ; ] ,  )B ‡ , 1Ñ*6 ~ *OB&amp;b&amp; 1Ñ  *6 ... " » u ~ U 4*6 j  f " fG} 7 » u 4*6Aî 7 &gt;  œ " Lb! &amp; &amp;fi..!" » u  +O~ -j "\$ØØ ^ fl+X  , 1Ñ*6 " "\$ØØ5 Aî5 \$ '  f -j 1Ñ*6 ... h ð " x  f "\$ØØ WØGy" ' fF  £+X"L} ~NpL ~ -j E L\$  µ ~ "D 4*6Aî í ^ FJNp "D  Aî í , F &gt; 5\$Ô1Ñ*6 " Lb!  2, H(6&amp;t » u, +O~</p>		
--	--	--	--

\N'- , Lu \* AîE÷0; ] " > ~ ' =)BAô k? - X ; F Ö  
~ ~ \!QP..f j 6 OP..f " P..f µ Øj ~ +eD fl %bO— 4\*6 ü ü+Ox4i  
7 " /+OxK 2, 7 X " A722, ^ 9 j A722, ( 45 Y+Xü ü+Ox4i 8 ...  
~)B"WA72\* — ü ü+Ox4i 9 = X \!QP. f93\$ µ " )BAô' =, +Ox4i 7  
x+Q ~ A722, j +Ox4i 8, ~ É " Lu+Ox4i 8 =+Ox " ~ A722, x+Ogÿ  
= " 45 ° A +O F ~ i < 2 J \* ~ ( 1Ñ\*6 ] ó • & É £ ¾ ?fl  
=%b)B 0 ° 9L ( ~ A722, F +G#k ‡ n B j B' /j , = - ° ~ #Z)B \* ~  
~ — ' ~ œ < 2 \* 3 ( 4\*6- 1Ñ] ó É £ ¾ ?fl=%b)B 0 ° 9  
L ( ~ A722, F TÖ +G#k ‡ n B j , B' /j ° ~ \$flÑ• ~ — ' ~ ,  
' = " G÷+Xd.¾ 6F9 f ~ ?¶K fl ^ g4iD fl ^ +eD fl ] H > , ~ A722,  
j É - æ j L ( = ° ~ (x ~ µLt j L ~ ( Bq} 1Ñ\*6\$5 ] , 1\  
N' " XF E \$%C^LbM ^ Lb\$G%? ^ LbF ^ ?- "r = 9 j L ~ ( F >|F E ^ "  
F +G#k ‡ n j B ~ \N'- x+Q ~ A722, Lö ] fLö >+d' ?fl" h < ( #q 9L  
(F ° TÖ ‡ n B j B ~

~ ~ 63< ' , Lu i å " \N'- =M0î5 7+X +ej ~  
~ ~ )BAô' =, ~ 4iD fl ^ EØ@ É — x+Q ~ "D4ÿ BNpL H 3>»  
L H 4\*6 > " FJE÷ i 2E ^ "D1 QO" ' n " j ¶ÿ A ) )B ‡ , " " \N'  
- X+OxE÷0; ] Aî5 BNp 3>»L HAî 7 " 63< ' , Lu ^ "D1 8 f Lî " \  
N'- ~ "D4ÿ i 2E ^ "D1 F ^ ~

N-OL  
 ISTIOYINB G POISITNS  
 2NITLY GPE JVIYN G Y QIY

)B ‡ ÔÂî í

" ( "° \*6 45 Âî í

~"d

\N'- ~"d k?- j +G#k ~"d ..O 20@ ~"d ~ \N'- >" ?f|O •)B 9L

( j +XO M"d3+5 " MOM"d " " ?f|O •)B 9L (M"d fLö" ~

N'- +X'd 8 j "d † „d " N'- +Ox ~"d " +X'd 5 6| +G#k+X'd ^

O 2+X'd ..5/F+X'd ~ i )à j B3 ...6 À " N'- 6| +G#k+X'd4Öj

O 2+X'd4Öj " 5/F+X'd4Ö " 8AÑàRì+X'd ~ "d x+O

Gyj ~ O 20@ ~"d x4ÿL~"Ø" 4\*6 > > f +G#k" "d O f ^ F2Ú

" 4\*6 " Eî5 Ý" "d 4\*6 †AîAÑF "d"dCX~"r > ^ 5 Ý" "d 4\*6 †F O! 4

\*6 " "d 4\*6 † \*"d"dCX >| É þKw "d 4\*6 †" ( "n 7ö ° ~

~ 04x 7 ö " "d 4\*6 j n"d 04† ^ %"a ~ \N'- " "d 4\*6 8"#q;

. ?æ. ~

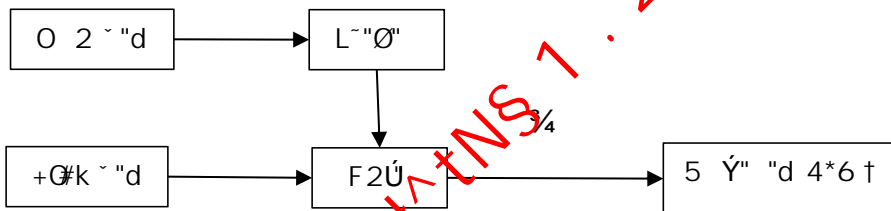

N'- " "d ^ n#q;/j ? .

§ ~"d" ( "° \*6 ^ 45 Âî í | å?æ ~

> N'- ~"d" ( "° \*6 ^ 45 Âî í | å

~"d2«L	\$Å	" ( /ý2«	^ n?ð »	"° *6Âî í	^ n ° A
+G#k" "d	O 2 ~"d	^ ^ ^ ^ ^ "X	L\$Ý	L~"Ø" ^	5 Ý" "d
	+G#k	^ ^ ^ ^ ^ "X	F 5	F2Ú	4*6 †

N-OL  
 İSTİFOLYND 9  
 POİSTİNS 7  
 2N TC  
 Y 9PE  
 YVÄY N 9 Y QIY:





L~"Ø"



F2Ú



MOM"d fLö"

istio ýñb g PQIS^tNs 1. 2N TC~Y gpe yviy N g ý Qiy:

N'- ~"D k?- 9 ~ +eD fl %bO— 4\*6+Ox4i ~"D ..O 2"Ø ~"D ~

~ ~ ~ +eD fl %bO— 4\*6+Ox4i ~"D

X ~ 4iD fl 4\*6E÷0; ] ~ 4i2„¾ ^"D#q 6F9 ~"D4y ' BNp 3>»L HAî

7L H >4y ~"D1 ' n x 4i" Gy 6F9 ~"D4y ' BNp 3>»L HAî 7L H

>4y ~"D1 ' n x ..!Q.d.¾ ~"D ... 4i" Gy 6F9 ~"D4y ' BNp 3>»L H

Aî 7L H >4y ~"D1 ' n x 4i2„¾ ^"D#q 6F9 ~"D4y ' BNp 3>»L H

N-O-I

Aî 7L H > 4ÿ "D1 í n ~ k j Z ~ "D í n " í n" j 2, H ^ K  
 œf F 8( ^ K & œf F 8( ^ Ji œf F 8( ^ K < œf F 8( ^ K Q œf F 8( ^ K  
 K) œf F 8( ~ § ~ "D 8"#q;?æ. ~

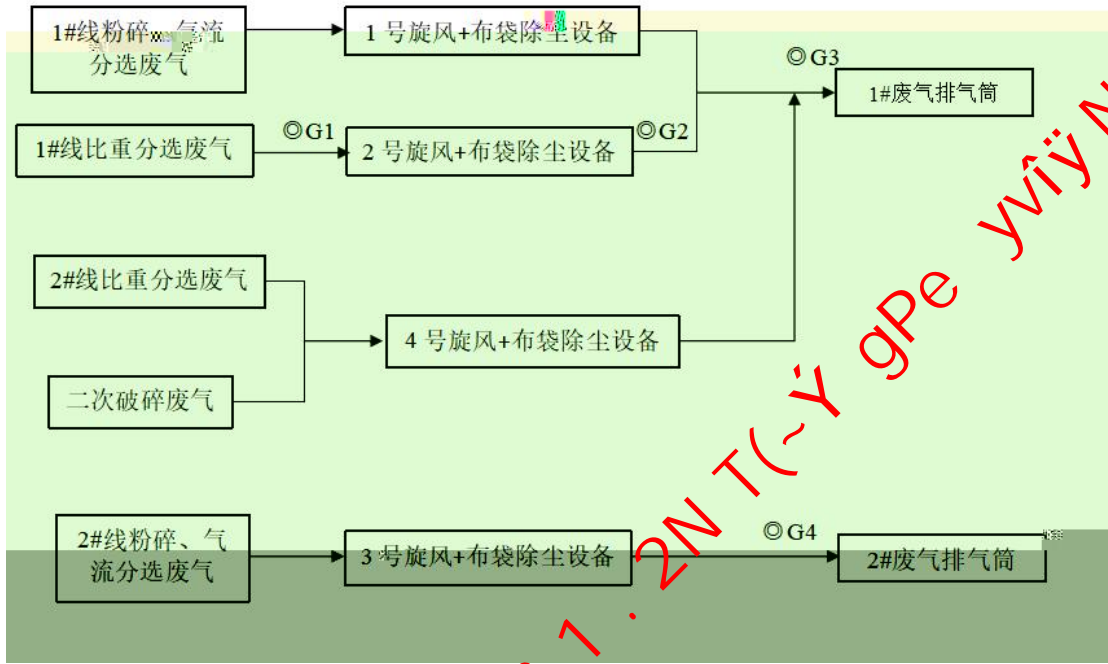

+0x41 ~ "D 8"#q; .



βNβ 3>>L H

N-O I-  
 isfioýñb g PQIS^TNS 1  
 2N T(-ÿ gPe jvüN g ý Qiy:



~"D1

~ - 0 2"Ø ~"D  
 \N'- 0 2"Ø 4yØ ð F 4\*6 >Q 0" ~ n ~



0 2"Ø ~"D 4\*6 8"#qð;

istioyñb g POIS7tNS7 · 2N TC~Y gPe JvÿN g y QIy:

N-O L



Lö"D5



"Ø ð F



"D1

№ 01  
İSFLİÖYÑB 9 PQİSİTİNS 7  
2N TC-Yöpe JvriyN g y Qiy:

N' - "D x+Oœ' n | àB ?æ

> N' - "D x+Oœ°\*6 | à 0?† >

"D =0	\$Å	" ( /y2«	' n ?	"°*6Aî í	"D) Q Ö ..1Ñ.	"°*6Aî í - #{&Ø Aî5
~ +d fl %bO— 4*6+Ox 4i ~"D	4i2„¾ ^"D #q 6F9	2„ H ^ K œf F 8 ( ^ ^ K&œf F 8 ( ^ Ji œf F 8( ^ K<œf F 8( ^ KOœ f F 8( ^ K} œf F 8( ^	94ô4÷ n	' BNp 3>»L HAî 7 ~"D ' "D1	Kfl " Ø " í	~"D ~"D1 k '
	4i" Gý 6F9		94ô4÷ n	' BNp 3>»L HAî 7 ~"D ' "D1	Kfl " Ø " í	' "°*6Aî í F ^ *
	4i2„¾ ^"D #q 6F9		94ô4÷ n	' BNp 3>»L HAî 7 ~"D ' "D1	Kfl " Ø " í	~"D ~"D1 k '
	4i" Gý 6 F9 ^ ..!Q.d.¾		94ô4÷ n	' BNp 3>»L HAî 7 ~"D ' "D1	Kfl " Ø " í	~"D ~"D1 k '
O 2"Ø	O 2	"Ø	94ô4÷	"Ø ð F	Kfl " Ø " í	"°*6 Ú í *

NOL

istioýnþ g poistns 1 2N Tÿ gpe jviý N g ý QIy:

\N'- F :U O k?- 5 4+OxAi 7F >| ~N'- FJE÷ 8\*6 3 pE  
 L\$ " \*1 L~ " \*p y \_ " —j h5\$ÔAi 7 4 3/8 >, F E (æ11y Ú í L}

> k?-Ai 7 }5 O? >

+Ox4i 7Ai 7	¿'	Ai 7 =0	}5
4iD fl.d.¼ 6 F93+5		,p VE^F1 j	+OxE L\$
		¼ j	+OxE L\$
		? wj	+OxE L\$
		OB?.d.¼ j	+OxE L\$
		.æF9E^F1 j	+OxE L\$
		_ Ø1 F9j	+OxE L\$
		#Ñe#q 6F9j	+OxE L\$
		+eD fl C+X2,¼ j	+OxE L\$
		4öÖ 6 À	+OxE L\$
		BNp; É	+OxE L\$
		BNp 3>»L HAi 7	+OxE L\$
		Q »M,e 6F9j	+OxE L\$



t oL~



y \_

N-01-  
 isfiojym g poistans  
 ANTK-ÿ SPE  
 jvityN g y Qiy:

\* ~ (

N'- F :U OL\$ x+Q \* ~ ( 9 , +G#k † n ^ ~ A722,, ~ [L HAî 7  
fLö; 2,, H ^ L HAî 7 ] \$ , 3>» ^ ~ É 5>ı ~ ( ~

~ ~ +G#k † n

6| x+Q +G#k † n fLö8#; +G#k † n fLö&0" +a)ß GL 5 O\$F ~

~ ~ j L \* ~

j L ~ ( 5 ~ A722,, ~ [L HAî 7 fLö; 2,, H ^ L HAî 7 ] \$ , 3  
>» ... ~ É 5>ı ~ ( " ~ 3>» ... ~ 5>ı>»5 O fLö > † j ~ † L\$ " ° O %  
" ?fIL" )ß ° \_ 9L ( 4\*6 45 ~ G+Xd.% 6F9 f ~ ?¶K fl ^ g4iD  
fl ^ +eD fl ] H >; ~ A722,, j É - æ j L ~ ( = ° ~ (x ~ µLt j  
L ~ ( Bq} 1Ñ 6\$5 ], 1\ N' " XF E ^ §% C^LbM ^ Lb\$%? ^ LbF ^ ?- "r  
= 9 j L ~ ( F >|F E ^ "F +G#k † n j B " x+Q ~ A722,, ~ [L H  
Aî 7 fLö; 2,, H " Lö ] fLö X E L\$ ~ A722,, Lö ] n j " ' M " > Lb  
7 Lb\$GÚ í " " ?f" h < ( #q 9L (Lö ] f ° TÖ † n B j B " a  
F 4\*6 " i )à j B3 " \N'- X E L\$Aî 5 OL\$ , ; j ~ L\$ œ ~ A722,,  
fLö j ~ N'- p \* Aî j ~ L\$ œ ~ A722,, fLö j " ' Lb#B ^ Lb\$G ^ Lb#q  
a ?- "r " 1V 8?ô93 - "r ~

N'- \* ~ x+Oœ45 j à ?æ ~

N-O L  
isfio ý ñ g PQIS ^ tNS ^  
ANTICOPY  
yvä N g ý Qiy:

> \N'- \* ~ x+0œ45 | á"wk>

¿ ' ' ' =0	\$À	1	W	)BAöAîAÑgÿ	Lu x+045 Gÿ	45 Ø#
+G#k ‡ n	+G#k	* 1	+G#k ‡ n			)ß G L 5 0\$F
~ A722, ~ [L HAî 7 fLö 2, H ~	+OxE÷0;	* 1	i ~			Lö ] fLö >+a" ?f h < ( #q9L (F °TÖ ‡ n ß j ß
L HAî 7 ] \$ ; 3>>	L HAî 7	* 1	i ~			" ?f L" )ß ° _ 9L ( 4*6 45
~ É 5>  ~ (	É 5>	* 1	i ~			

N-O-L

isfioÿng

POIS^tNS 7

2N T

gpe

yÿN

g

ÿ QIÿ:





1 ~ t L\$

%6



1 ~ t L\$

N-01-

ISFIÖÝÑB g PQIS^tNS 7 : 2N TC~Y gpe jvÿN g ý QIy:

+Qb ÔD /°

\N'- +Qb ÔD /° j D +OxE L\$ 93\$ µ " i P..fLflâ)à j B3

" \N'- )B ‡ Ô- 7 >)BAôLf!â F " D E L\$+Ox4i = X \!QP..f 93  
\$ { µ " i )BAôLf!â" ?f-1 AîAÑDOJL \* \$Lb ÔD /°#{Gÿ. Ôz ~?æt  
& " . "N'- EØB ‡ 7-%C^: F Lb ÔD /°?-"r ~

f )B ‡ ÔAî í

)B ‡NpL Lb93Aî í

~ ~ ~ U f Ö

A ( " ...@O- )B ‡ » & ~ UN· x, 5Ff " f X\$fGüj )B p 7 x " 7 x  
' Ö " § ?æt & ~

~ ~ Lb\$GÚ í

\N'- " )+OxE L\$^ ~ É ^ ...j L \* ~ t Ô' MG÷Xdx#. F " f  
g)B"WA72' %b7 Lb\$G~



i ~L\$' %6

E L\$' %6

N-01-

istfioýnb g POIS^tNS^T : 2N^T^Y gPE jviýN g ý Qiy:

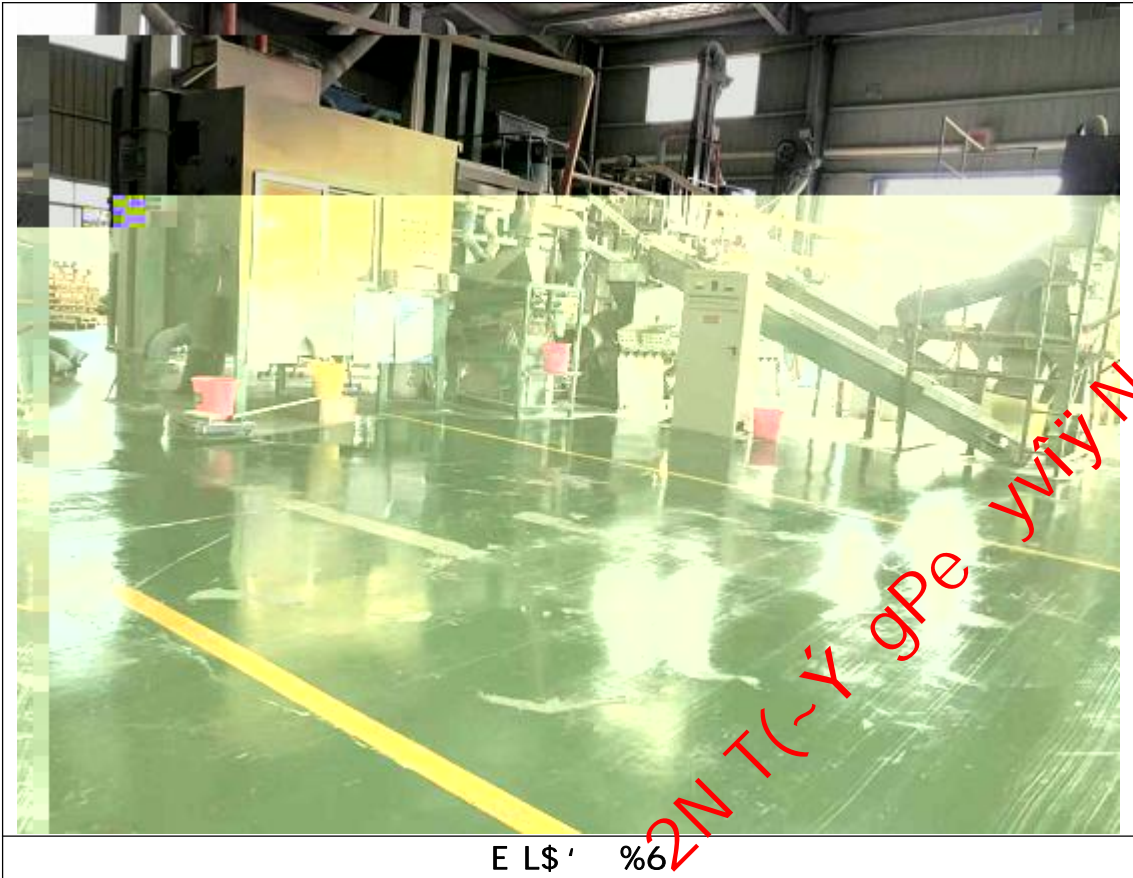

E L\$' %6

~ ' ' ; "d- #{ -

\N'- " X E L\$?fIG xAî5 ' ; "d- #{ - ' ' (w?æ; . Ö



' ; "d- #{ -

f Aî í

N-0 I-

isfio'ýñb g POISYTN\$ 7  
2N T(-Y gPe JviyN g ý Qiy:

~ )B ±1Ñ6 Ö " 4yf ° )B ±1Ñ6 ^ j ~ 1Ñ6 f Ö ~?æt . ~ ~  
 ~ ~ t j k " "d ´ n Aî5 " "d ´ n 7 (| ~  
 ~ ~ t, 4 Z ~"D ´ n " Aî5 ~"D ´ n 7 (| ..G÷g ~  
 ~ ~ t j j L ~ ( t L\$ " Aî5 j L ~ ( C^ j 7Aö| ~  
 ~ ~ t j ´ n\$À" 4yAî5 7Aö| ~



~"d ´ n

"Ø ´ n

´ n\$À

j ~ t L\$

N-01-  
 ISFIOYÑB g POISYNSÿ  
 2N(TC) g pe jvÿyNg ý Qiy:



08\\* ~ nj

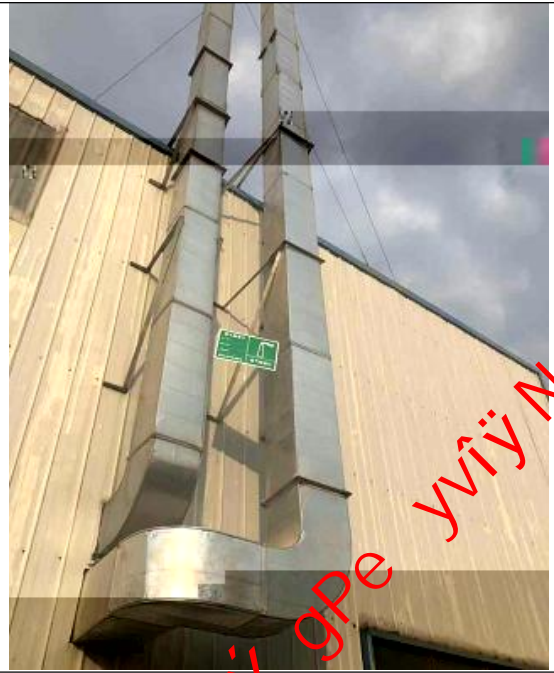

~"D' n

)β Aî í ~ Ctœ 9 < & :m . i á

N'- Lu k ~ Ct 7 s ~)β ~ Ct 7 s ~ k ~ CtN"; ~ S

4N')β Aî í ~ Lu ~ Ct i á?æ; >

> 4N')β Aî í ~ Lu ~ Ct i á>

μ Ø	" \$À	"o*6Úí =0	~ Ct ~ 7 s ~
2«»	+G#k ~ "d	L ~ "Ø" ^ F2Ú	
~ "d	+Ox Aî 7	G ÷ X ~ ; Aî 7 x + O x Aî 7 m 7- > i XF /° t +  , } 5	
~ "D	+O x E ÷ 0;	BNp 3>» 2E ~ "D1 ^ -j E L\$FJ Np	
	O 2"Ø	"Ø ð F ~ "D1	
*	+Ox ^ +G#k	i ~ Ø L\$ ~ i ~ 45 x 08\* ~ t j p x + G#k ‡ n f Lö & Ø x	
8AÑ			

i )à j i á ~ N'- )β Aî í 9 < & :m . i á?æ ~

2N T C Y G P E  
 yvü N g y Qiy:

N O I

> )B ‡ Ô 9 < & :m . i å O?† >

" \$À

)BAô' ='°\*6Úí

,Lu)B O; Ú í

P..f?-"r

7  
ó

~"d

+G#k  
" "d

"X"^^ ^ ^  
Ø=( "Ø

\N'- † j ^"d3+5 N« . í  
M" ~ ~ - 6#q~4ÿL~"Ø >  
O 2 ~"d > f +G#k ~"d  
O f4ÿF2Ú 4\*6 > ~  
5 Ý" "d 4\*6 † 4\*6 ~

\N'- † j " . í M" ~ ~ - 6#q~  
O 2 ~"d4ÿL~"Ø > > +G#k ~"d O f4ÿ  
F2Ú 4\*6 > ~ ~ 5 Ý" "d 4\*6 †  
4\*6

N'- F ^ ~"d ~Ei' 5 Ý" "d 4  
\*6 †F "d"DCX7 ö ~ O O ~  
O ^ O  
O ^  
O ~ f " ( > | É"  
"d5, 8 ^ n 7 ö ° ~  
> ] O4x7 ö

(Ø)

7

~ 4iD fl ^EØ  
@ É — x+O  
~"D

2, H ^K œf F 8( ^  
K&œf F 8( ^ Ji œf  
F 8( ^ K<œf F 8  
( ^ KQœf F 8( ^ K}  
œf F'8( ~

~ 4iD fl ^EØ @ É — x+O  
~"D4ÿBNH H 3>»L  
H 4\*6 > ~ FJE ÷ ~"D1 Q  
O" ^ n ~ ~"D1°Q @ n

8

B

~"D

B.

" P t9# ABS \$

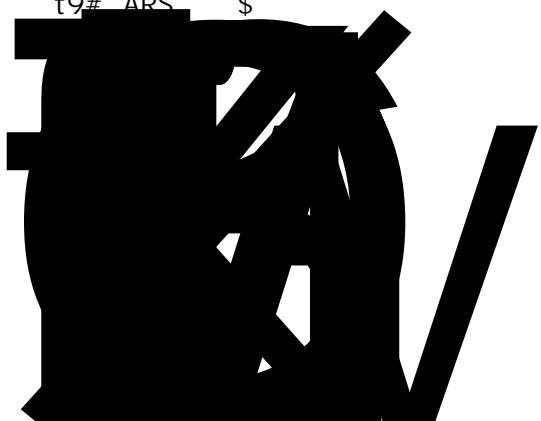

Ó  
C

n

÷

ó







)B †Np Lb93Ú í	j L F æð%?^ & &fi	<p>- F :U ) O œ' ;"dFP@  " -  N'- #, œ, ^ #, Lb1y Ø  M »N' ~ ÖB' " ^ #, Lb1y  &gt;  o1Ñ*6G L Ñ' " f 9'  " ^ #, Lb1y&gt;  o1Ñ*6G L  , ?-"rF &gt; AíAÑ^ *Aí ~  ( ~AÔO:m É Ö z  ° ] *, 4N'Np Lb93  Ú í " *Oß... , » uN·Lb  Øx œ~ U 4*63+5 " -j  +Ox ^F E^ ^C^ E:0; ],  )B † " 1Ñ*6 ~ *Oßb&amp; 1Ñ  *6... » u ~ U 4*6j  f " fG} 7 » u 4*6Aí 7 &gt;  CE " Lb! &amp; &amp;fi..." » u  +O~ -j \$"ØØ ^ fl+X  , 1Ñ*6 " \$"ØØ5 Aí5 \$'  f -j 1Ñ*6... h d " x  f \$"Ø O WØGy " EF  E+X " L} ~Np ~ -j E L\$  µ "D 4*6Aí 1 ^ FJNp "D  Aí í ; F &gt; B\$Ô1Ñ*6 " Lb!  2, H6&amp;Ł » u, +O~</p>	<p>N'- ZAí5 \$"Ø +ej " " 4ÿm )B  Aô' =u Ø " " f °O- )B † » &amp; ~  UN· x f X\$fGüj )B p 7 x</p>	:m )BAô œ' = ] ?-"r
" ?ð93F		<p>9 - æß G ?-"r?ð93´"  *Aí " Aí5 42«´" 7  Aö " f X † j FAí5 ~"dG÷  g " Aí5 ~"d#qGyAÑı  5 ~</p>	" Aí5 ?ð93F)B 7Aö(	:m )BAô œ' = ] ?-"r

2NITC-ÿ gpe jvÿñN gÿQIÿ:

istfioÿñg  
POSI-TNS1

N-O-L

<p>+Qb ÔD /°</p>	<p>4ÿ)BAô#{1' " \N'- +Ox  E L\$N«Aî5 2E +Qb Ô  D /° ~ i " ?f-1 AîAÑ  .DOfl * §. #GÿÖz "N'  - Lb ÔD /°93\$ µ O  &amp;Ø \$fGüj o Ì ~ UI x f  N'- †+  EØ3\$, ?ô B *  Aî µ Ø " X \N'- Aî5 ,  +Qb ÔD /°93\$ µ " = ' à  * u"A j ^ kL ^ Q1y)B  ‡ ON'- ~</p>	<p>\IQP..f E L\$ = X \IQP..f 93\$ {  µ</p>	
<p>)B †1Ñ6 &gt;- #{</p>	<p>*OB... )B 1Ñ6 f Ö " Aî  OBCL )B †1Ñ6j . "G} 7  CL 1Ñ6 CE x *OB... )B  - #f Ö "G} 7 CL - #{  CE Aî5 )B †- *6</p>	<p>" f °)B 1Ñ6 f Ö " AîOBCL )B †  1Ñ6j . "G} 7 CL 1Ñ6 CE x 1 J  ° O ð#{j . - #{</p>	<p>:m . )BAô œ' = ]?-"r</p>

N-O-L

isfioýñb g poisa tns 7 . 2N T(-ÿ gpe yviñN g ý Qiy:

\*AîN'- )BAô Ô z k?-5 ACE> \*AþœÑ' G L Ñ' a °

\*AîN'- )BAô Ô z , k?-5 ACE> \*Aþ

N'- † â

\N'- j" ?fl=%ö)ß 0 ° 9L ( / x 7 X5 5H É \*AîN'- " N'  
- O +X~ \_L¶+e\$À† † oF >|+Ox "O +X† o k ' MO j É Ø2E" k \*  
1 MO 4Ö É Ø2E" f ] +OxE L\$ ^ ^ 1y+Ox W+XoMO j É Ø  
2E×5, 8 < ^ O 2 œ 1yM+Ox W+XoMO 4Ö É Ø2E" N·AÑN'- 6C]5  
JÒQ ^ ' » 3+5 ^ z 8 Ø 8 ö fl #qîi ^ 2„¾M+e 6F93+5 1yAî 7  
1y" i 2 j N·#{. ° \ †, AîAÑô Qj / x 7 X5 5H É œ x æK 2,,  
4Ö 7 X ~

x J5 · 1V8 W

\N'- \*Aî1V8 É x J5 · B3/ 7 , - / \ ° ~ / ! ~ -(  
£?-"r " = ¾É" ?fl-1)ß † Ô/-! ..L f \*AîN'- - ~ \ 0' - ° " N'  
- 1V8 - æœ' Ø x J o1 ~

)ß †)à(æAô' 5 ACE

~ - WD)ß †

FJE÷ WD)ß †- #{ #&Ø}, 4- #{ 7 7Aô' 7 w? ¾ " %  
Cª É)ß †O"DCXgÿ 7 ö ° ~ ] ..4x7 ö, ?-"r ~

~ - ' > "d)ß †

\N'- ' > "d)ß †CXgÿ- #{5 ì 1V8 É ' > "d)ß †CXgÿ 7 ö ° ~

~ ] 2« 7 ö?-"r " ' > "d)ß †CXgÿ8 > ~

~ - )ß †

+a - #{5 ì -; \* " N'- j 93\$ 4 O&Ø} µ | L\$ ^ LL\$ )ß †  
w7-%Cª É )ß †CXgÿ 7 ö ° ~ ] , - ( £ ~ 7- j 7 ö?-"r ~

~ - ' ; "d)ß †

p ' ; "d)ß †)à(æ #5 ì . " \N'- p X j ' ; "d 4"dCX #  
, )à(æ #{ | 1V8 É ' ; "dCXgÿ 7 ö ° ~ - 2« 7 ö " j ' ;

"d"dCX† > ~

~ - O )ß †

pN'- O )ß †)à(æB3 œAô' . " \N'- O - #{ 7 7% Cª É O )ß

N-OL-ISTOXYM G POISYNS 1 2NITLY GPE VNYN G Y QIY:

‡CXGÿ7 ö ° ] , 94x7 öL l ~

)ß ‡ j ýAô' 5 ACE

~ - ' > "d)ß ‡

\N'- ~ "d k?- j Æ , +G#k" "d ~ ~ "d ' n kGÿj ~ +G#k

" "d4ÿF2Ú F >|N. 4\*6 ~ N. 4\*6Eî 7 >FJE÷ 2 o" "d1Ñ5 ' 5 Ý" "d 4\*6

†F >| \$! Ö 4\*6 ~ " "d 4\*6 † n" d 04† ' % "a ~

~ - )ß ‡

FJE÷) \N'- F >|Aî 7 , N.AÑ . ~ \N'- :UF OL\$FJE÷ 8\*6 Aî

7 3 p ~ F9+X)ß »Aî 7 œÿ \_L} 1y Ú í 4\*6 > \ †+| % Cª E J 1

J †+|)ß ‡ ' n 7 ö ° ~ - 2« 7 ö ~ ) E)ß ‡ j ýE†

? ~

~ - WD)ß ‡

\N'- F :U O ~ "D k?- j 2, H ..M+b' k&ó" j ] 2, H 6 94ô4÷ ' n2, H

... 4ô4÷ ' n2, H ~ N'- +Ox4i 7G÷+XO fD fl W» ¢ ?+Ox4i ~ j O

FAî 7 ~ +OxE÷0; X öL 3+5 ] F >| ~ 3+5 [ BNp 3>»Lö H ~ BNp 3>»

Lö H 4\*6 x)• Eî : ~ 4\*6 >2, HFJE÷ Q ' "D1 ' n xN'- +O

xE÷0; x+Q M+b' k&fJE÷LöD5 F >| f Lö >4ÿ#k W&ÝhLt 4\*6 > E8#

Q O" ' n xN'- FJE÷ —j E L \$FJNp . 4ô4÷ ' n, 2, H ) +Ox)ß ‡FP@j

ý ~

1 J 9 G÷ \)ßAô \* AP) : F ~ "DF >| 4\*6 ~ . ~ "DEî 7 ' n ~ l )

\$ WD)ß ‡ j ýE† ? ~

~ - \* ~ (

\N'- x+Q +G#k ‡ n\$S+a)ß G L fLö5 OF ° p 2 ‡ n 4\*6 †Lö ] 4

\*6 08\ J ~ ( Ô5 \* ~ ( 4\*6 ~ j L ~ ( Ô5 9 j ~ 4\*6CtCX. } 4

\*6 ~ ! = J ) \$)ß ‡ x+Oj ý ~

kGÿx f

\N'- "d" ( kGÿx f 7 7 j ~ i O; 6 À . ~ N'-

~ "d ' n kGÿj ~ "d4ÿF2Ú N. 4\*6 > ' 5 Ý" "d 4\*6 † ~ \N'-

kGÿx f x f 7 7 j ~

N'- WD" ( kGÿx f 7 7 j Ji ~ i O; 6 À . ~ N'- Ji [MOA :

NOI - SFIOÝM g POISÝNS 1 ZNTC-Ý gPE JVIÝN g ý QIy:

4xk1ÑG L +cB', kGÿj

G ò >

i G ò >B3 i å " " \* ; 5 ACEÖ

~ - \N'- G÷+X §B3 ^ 5 5 /j1yJ/ý G ò > ? " G ò >B3  
)B ?¶- ¶N'- j 4 WD)ß ‡ Ô- 7 " B3 5 Ì > > , Aï65\_1 \  
N'- \*Aï " Æ \* ý ) ??æ~

~ - FJE÷)à j B3 . G k?- £# , )ß ‡L N"j ; ý " N'- FJE÷F9  
+X)ß Aï 7 ^ 8\*6 3Aï+OxAï 7 } 5 œf ÿ \_L} 4\*6 Ú í Aæ ,  
! h ' n ~

+Qb ÔD /°?-"r

FJE÷AÑ' . N'- +OxE L\$MÖ >|, +Qb ÔD /° j " N'- +O  
xE L\$ 5 ü5 ÔMØï5 , +Qb ÔD /° ~ +a ¾ +OxE L\$ 5 ü5 Ô  
, +Qb ÔD /° 5 [ X +OxE L\$ , +Qb ÔD /°93\$ µ " ! \N'-  
O >, +Qb ÔD /°Aï5 ?-"r ~ B \_ ÖN'- +OxE L\$MØï5 , +Qb  
ÔD /° ~~XXXXXXXXXX~~

k5 ACE

" ?f=‰)ß O ° 9L ( / x 7 X5 5H É \*AïN'- 1V8 - æ...'  
Ø x J o1 " 1V85 ÝKwp 2 k ?ô B " N'- F9p 8\*6 x X U I :m , \Aô' p  
\*, 4N'" Lb"° Ú í ..)ß ‡1Ñ\*6 Ú í " )ß Aï í! hF E " ( ,  
n7-%C^ p >|, )ß ‡ 7 ö ...kGÿ x f?-"r " XG÷ -( ~, Np Lb93Ú í ,  
}

bio

F

Ñ' GL Ñ' a .

( É / x 7 X5 5H ÉN'- ) ß † j ýAô' Öz ° ; 1° É Ö  
z ° ~ ; > | oAŁ f „ ~ 4ÿÑh ° ° = † ; Ö

O ^ N'- ' = ??æœN'- \* \ i å

~ O ^ N'- ' = ??æ~

N'- +a\$Güj i 7 x ~ \$fi i ~ Ò Ó ' ~ xN'- O Cq' ?fi-  
L||+e\$AO ° 9L ( † o ^ 5, 8 < 1y ° +X' " ° - 9 O' fl+Xæ #ZQ-+X  
~ ,« \$fi 1\ ' ~ X:m „ É Öz ° ] 4N'" Lb"° Ú í , } ; " A  
p ~ I < ?B N'- 9 É Öz ° „ „ \*Aî ' p ^ WCX ^ ?ô O „ MŁ Lb93 ^ "

Lb"° ) 1 æÚ í F > | \*Aî ~

~ ... ^ N'- \* \ i å ~

N'- } ¾\$Güj 5 ÝKwy ° O +X' ?fi \_L||+e\$AO ° 9L ( ; +Ox  
E L\$ ^ ; 5, 8 < ^ ; O 21y ° +X' MO É Ø2E" k \* 1 MO É Ø  
2E ~ N'- / 4\*6 ^ 45 ^ Y+Xj L ~ ( 4Ö . X ° f ] ~ g+eD fl4Ö  
X ^ 9 j A722« ~ ( ~ ~ )ß"WA72&~ X ^ ~ )ß"WA72\* X ° à  
\* O ~ +eD fl f % † 04\*6+0x4i ... O ~ A722 „ A72\* 45 Y+X+Ox  
4i ~

x æØ x Ö+Ox5 5H É 7 X ^ K 2 „ 7 X ~ k?- 8" Ö ~ 4iD  
fl ^ EØ@ ÉFJE÷ 04xd :¾ ^ ..4xd :¾ ^ 94xd :¾ ^ "D#q 6F9 ^ M+e 6F9ly ¿  
+OxK 2 „ ... ~ 4iD fl A722 „ x ~ )ß"WA727& ^ ~ 4iD fl A722 „ FJE÷\$' 8 ^ n  
JÒQ ^ » f @ » ^ >æ71y ¿ +Ox5 5H É x ~ )ß"WA72\* FJE÷>æ7 ^  
G} ^ n JÒQ ^ » f @ » ^ >æ71y ¿ +Ox5 5H É ~

N'- = ' 45 [ " ^ Ky ^ K ^ .g1yGyH ; g+eD fl ~

N'- k ^ Ct 7 s ° f ] )ß ^ Ct 7 s ° k ^ Ct, ~

k?-Aî 7 Ö 4iD fl.d :¾ 6F93+5 ^ 8 Ø 5 ü5 ^ ' » 3+5 ^ z 8 Ø  
8 ö fl #q4i ^ JÒQ ^ , ' "Ø& „ ^ >æ7 j ^ 7+X +ej 1y ~

... ^ N'- \*Aî , " Lb"° Ú í œ-"r

N'- X O ; AîAÑ ^ \*AîE÷0 ; ] N«m „ É Öz ° „ ?-"r ° fGy&Ø > ;

Ö

istioyñb q poistñs 2NLCY GPO yvñN g ý Qiy:

N-OL

~ 0 ~ Q N' - \$5#1+Ox"d £  
N' - i N«G÷+XxF ; +Ox 8" ^ ° \_ .Aî 7 " Q 8 Ø F x f"d £ " O -  
Ø>|\$5#1+Ox " Q N' - \$5#1+Ox"d £ ~  
~ ...~)ß †Np Lb93  
N' - #, œ, ^ #, Lb1y ØM »N' ~ ÖB' „ ^ #, Lb1y>| o1Ñ\*6G L Ñ  
' " f 9' „ ^ #, Lb1y>| o1Ñ\*6G L ; ?-"rF >|AîAÑ^ \*Aî ~  
( ~ AÔO:m ĸ É Ö z ° ] \*; 4N'Np Lb93Ú í " \*OB...;  
» uN·Lb Ø x œ~ U 4\*63+5 " —j +Ox ^ F E^ ^ C^ E÷0; ] ; )ß † 1Ñ  
\*6 ~ \*Oßb& 1Ñ\*6..." » u ~ U 4\*6j f " fG} 7 » u 4\*6Aî 7 > U " Lb  
! & &fi..." » u +O~ —j \$"ØØ ^ fl+X· 1Ñ\*6 " \$"ØØ Aî 5 \$ ' f —  
j 1Ñ\*6... h ð " x f \$"Ø O WØGy" ' EF E+X" L} -Dp ~ —j E L\$  
µ ~ "D 4\*6Aî í ^ FJNp "DAî í ; F >|5\$Ô1Ñ\*6 " Lb 2, H(6&Ł» u, +O~  
~ 9 ~ "d" Lb"  
N' - † j "d3+5 N« ĸ í M" ~ ~ - 6#g.  
4yL~"Ø >; O 2 ~ "d > f +G#k ~ "d O·f4yF2Ú 4\*6 > " 5 Ý" "d  
4\*6 † 4\*6 ~  
~ ~ ~ "D" Lb"  
~ 4iD fl ^ EØ@ É —x+Q ~ "D4yBNp L H 3>»L H 4\*6 > " FJE÷  
~ "D1 Q O" í n ~ "D1° Ö ~ 1V8-( £ 7 ö?-"r ~  
» f @» ĸ x+Q ~ "D4yLö"D5 fLö #k W&ÝhLt 4\*6 > " FJE÷ ~ "D1°  
Q O" í n ~ "D1 Q Ö ~ 1V8-( £ 7 ö?-"r ~  
N' - pAî \$"Ø +ej ; F9+X~ ò' ÉMF D O+Øj à+X\$"Øj í "D"  
( í n L l œ#{GyØ# ~ ] -1\ 9 ^ Lf!â ~ ° ~ ~ ?δ ° ; ?-  
"r 26"Ø "D4y ) ' F í n " "D ~ F /° EØß † O&Ø" fQ ¼' M  
2E : ~  
—j E L\$ µFJ í Np" L} ~ 4ô4÷ í n ~ "D) E L\$ µ)ß †; j ý ~  
O 2"Ø Ö8#Ø 2 p X < < NfQ O" í n ~  
~ ~ ~)ß † " Lb"  
N' - ~ F9+X~ ; j àAî 7 " f 8\*6 35 Q Aî 7 " ) x+O ; Aî  
7G÷ ýM7 #, ^ L~ ^ hN#y Ú í " ý A ) EØß †; j ý ~

ISTROYNĖ g POISHTNS TON TICYPPE WIVYN g ý QIy:  
N-O-L

~ - \* ~ ( " Lb"o  
~ 9' C+\$ÄF ^ yGy F ^ a F 45 ~ " AÖO:m , 42« \* ~ f  
Lö ^ 46 ..5, 8 Y+XÚ Í " U/- 6 42«+Ox ~ ( ^ ~ É-\$ Ö n F\$' +G#k †  
n j n B ■ i L ~ ) ^ i L ~ ( VCX: ~ É XC F 1 \$ 6E±0 ~ AÖO:m -( £  
)B † 0 / " f " Ô> i L ~ ( E O+6 1y)B { ~  
.di 4 5>I>> ^ \* 5>I f ^ ~ #k W&Y ^ ~ "Ø ^ L HAî 7 ] \$ : B>»  
¾ i L ~ ( † ^ " Ô 9 i L ~ ( 45 CtCX: } 4\*6 x#0 @ 30 " 5 " P' | 16 d 2 # " W P

! JOH



" ( >| É" "d5, 8 ' n 7 ö ° ~ > ] 04x7 ö ~  
~ ... ~ "D ~ U W9j ( ' n ò' >| Y#U2 ' Ø 7 ö É J 1 J U  
W9j ( ' n x f 7 ö ° ~ ~ ] , , 7 ö l ~ "D1°Q Ö  
9 ZQ \* \$ 2Éz · 93\$, \* 1 2E : " ' nFO) · 7 ö l U l  
>| ~ f +Ox ~ "D ' n >| É WD" ( 5, 8 ' n 7 ö ° ~  
> ] ..4x7 ö ... 4ô4÷ ' n- x# ÖL l ?-"r ~ "D1 Q Ö9 ZQ \* \$  
2Éz · 93\$, \* 1 2E : " ' nFO) · 7 ö l U l >| ~ x \$"Ø  
j ~ "D ~ %Cª ÉMF D O+Øj à+X\$"Øj ' "D" ( ' nL l œ#{GyØ#  
-1\ 9 ^ Lf!å ~ ° ~ ~ ] 7 ö ?-"r ~  
~ 9 ~ ~ N'- t+| >| É J 1 J t+|)ß ‡ n 7 ö °  
~ ~ 2« 7 ö ~  
~ ~ kGy7 7 ~ 63hGyj ~ x fGyj x 63hGy  
j ~ x fGyj ~ ~ "D ~ 94ô4÷ ~ ] Ji ~ nGyN« x f X  
µ ~ = F ' [ GyH , +Ox ~ "d ~  
~ ^ f )ß ?-"r  
~ O ~ N'- \$)ß ?-"r ~ \ ' = l L ¼É Öz °. °, \*Aî µ Ø "9  
N'- \*Aî ' &Ø µ Ø ^ ?ô Q1y \*GyW F ~ ~ 9' # »# ?ô?-"r "Gyà Ö'  
\*AîN'- , )ß ‡ j ýAô' • & x 9 8 ' = { CSC, E ÷ / Ø Ø ~ )ß ‡ j ýAô  
' • & ~ Õ A pGyà Ñh  
~ ... ~ h)ß - 1Ñ ~ B' \$fGüj )ß p ^ 2)ß ‡- \_LCCØS) B N'- \*  
AîE÷0; ] , h- -1Ñ6 ~ - - \*Aî } AÔO >| 9 < & f Ö ~

istioýñg poistñs 1 2NTCÝ gpe jviñN g ý Qiy:

NOL



<p>4ô4÷~"D</p>	<p>—j E L\$ µFJ ' Np'' L} ~ 4ô4÷' n ~ "D) E L\$ µ)B ‡, i ý</p>	<p>—j E L\$ µFJ ' Np'' L} ~ 4ô 4÷' n ~ "D) E L\$ µ)B ‡, i ý</p>	<p>E L\$ " 4ÿ—j FJNb</p>	
<p>O 2"Ø</p>	<p>"Ø ð F 4*6&gt;+a' ' 1Ñ E8#&lt;Nf' n</p>	<p>„&gt;I"Ø ð F &lt;Nf' n</p>	<p>O 2"Ø " 4ÿ„&gt;I"Ø ð F " ð F &gt; ~"D4ÿ&lt;Nf' n</p>	
<p>+ej ~"D</p>	<p>4ÿ ) ' F E8#' M 2fΩ 4' n</p>	<p>) ' F ' n ~ "D F° EØB ‡ O&amp;Ø' fQ ¼' M 2f:</p>	<p>N'- ZAî5 7+X +ej</p>	<p>N'- LuF &gt; E÷O; ] =MØî5 7+X +ej</p>
<p>Aî 7F &gt; </p>	<p>F9+X~ , j àAî 7''+OxAî 7 m 7- „ &gt;I XF /° †+  }5</p>	<p>N'- F9+X~ , j àAî 7' f 8*6 35 Q Aî 7'' ) x+O , Aî 7G÷ ÿM7 , L' hN#ly Ú í ÿ A ) EØB ‡, i ý</p>	<p>" 4ÿF9+X~ Aî 7'' 8*6 3 pE L\$'' † oL' ..Aî 7 ÿ _1y Ú í</p>	

N-OL  
 istfioy@polska.pl  
 2N T C ~ y g p e y v i y N g y Q i y :

* ~(	iL ~ (	A72,, j 8+0x4i ~ É	~ 9' Ct\$AF ^ yGyF ^ a F 45 ~ l ~ AÔOm 4 2«* ~ fLö ^ 45 ..5, 8 Y+X Ú í ~ U/- 6 42«+0x ~ ( ^ ~ É-\$ Ö ' n F\$' +G#k ‡ n ] n B ~ iL ~ ( ^ iL ~ ( ^ WCX: ~ É XC'F 1Ñ'6E:0; ] ~ AÔOm ~-( £)B ‡ Ô?- "r ~ >  iL ~ ( E O+6 1y )B { 5 ~ .d.¾ 5> >> ^ ~ 5>  f ^ ~ #k V&Y ~ "Ø ^ L HAî 7 ] \$ , 3>> n ¾ iL ~ ( † ~ Ö 9 iL ~ ( 45 CtCX ) 4*6 x+G#k ‡ n fLö > Ô +a)B GL 4*6 "Ffl} :!O' ~ É ~ ^ iL ~ ( † ~ 9 É iL ~ ( CA" x f 7 ö ~ ~ ~ ?-r *	)BAô' =, ~ A72,, j 8+0x4i ~ É ~ 8+0x4i Z+0x ~ = X !QP..f 93\$ µ ~ i É - æjL ( = ~ ~ iL ~ ( Bq} 1Ñ'6 5 ~ µ Ø G÷+Xd.¾ 6F9 f ~ ?¶ K ^ g4iD fl ^ +eD fl ] H > , ~ A72,, 45 E:0; = 9 i ~ 1Ñ' *6 ~ ~ A72,, ~ [L HAî 7 f Lö2,, H ~ 9 08\ * ~ 4*6 45 ~ LuLö ] fLö >+a" ?fl'h <( #q 9 L (F °TÖ ‡ n B j B ~ )B ‡ i ý E ‡ ?	)BAôAîAÑ ~ A72,, j 8+0x4i ~ É ~ 8+0x4i ZF :U ~ i < 2 * ~ ] ó • &#Z)B * ~ ~ - ' æf ' = µ Ø G÷+Xd.¾ 6F9 f ~ ?¶K ^ g4iD fl ^ +eD fl ] H > , ~ A72,, 45 E:0; = 9 i ~ 1Ñ'6 ~ A72,, ~ [L HAî 7 fLö2,, H ~ 9 08\ * ~ 4*6 45 ~ LuLö ] fLö >+d" ?fl'h <( #q 9L (F °TÖ ‡ n B j B ~ ))B ‡ i ý E ‡ ?
	Ô+a 9CtCX } 4*6 4 5	~ É ~ ^ iL ~ ( † ~ 9 É iL ~ ( CA" x f 7 ö ~ ~ ~ ?-r *	\N'- j 6 OP..f ~ \!QP..f µ Ø ~ 5>  f ... "Ø x+O" N'- x+O , iL ~ ( k? - _ ~ 5>  ( ... \$ , ~ 3>> "Lö ] fLö > † ¾ i ~ † L\$ " f " " ?flL" )B ° _ 9L ( 4*6 45	\N'- j 6 OP..f ~ \!QP..f µ Ø ~ 5>  f ... "Ø x+O" N'- x+Q i L ~ ( k? - _ ~ 5>  ( ... \$ , ~ 3 >> "Lö ] fLö > † ¾ i ~ † L\$ " f " " ?flL" )B ° _ 9L ( 4*6 45	
+G#k ‡ n	Aî5 ‡ n1Æ' +a)B G L \$F	† j Aî5 O 4+G#k ‡ n fLö&Ø" +a )B GL 5 O\$F			
O ...' ; "d	) +Ox J j ~ É ~ ^ i ~ † ^ 1y UI 9 É Ö z ~ œ( £ ° _?ô93~"r G÷ Lb\$G Lb7 Ú í ~ Lb' N'- F :U ) O œ' ; "dFP@ "	) +Ox J j ~ É ~ ^ i ~ ^ i ~ † ^ 1y UI 9 É Ö z ~ œ( £ ° _?ô93~"r G÷ Lb \$G ^ Lb7 Ú í ~ Lb' N'- F :U ) O œ' ; "dFP@"	+OxE L\$ ~ É ~ ^ i ~ † ^ " 4ÿG÷ +Xd# . F ~ f g)B"WA 72' %b7 Lb\$G		

NOL

ISTIOYMB 9

POISITNS 1

2NLU XGPE JVIYN 9 y QIY:

)B ±NpL Lb93Ú í	j L F æð%?^ & &fi	<p>N' - #, œ, ^ #, Lb1y ØM »  N' ~ ÖB' „ ^ #, Lb1y&gt;  o1Ñ  *6G L Ñ' „ f 9' „ ^ #,  Lb1y&gt;  o1Ñ*6G L , ?-rF &gt;   AîAÑ^ *Aî ~  ( ~ AÖOm, É Öz °  ] * , 4N'NpL Lb93Ú í ~  *OB... , » uN·Lb Ø x œ~  U 4*63+5 ~ —j +Ox ^ F  E^ ^ C^ E;0; ] , )B ‡ „ 1Ñ  *6 ~ *OB&amp; 1Ñ*6 .." » u  ~ U 4*6j f ~ fG} 7 » u 4  *6Aî 7 &gt; CE ~ Lbl &amp; &amp;fi..."  » u +O~ —j \$"Ø Ø ^  fl+X· 1Ñ*6 ~ \$"Ø Ø5 Aî5 \$  ' f —j 1Ñ*6 ... h ð ~ x  f \$"Ø O WØGy" ~ f f E  +X~L} ~NpL ~ —j E L \$ µ ~  "D 4*6Aî í ^ FJNp "DAî í ,  F &gt; 5\$Ø1Ñ*6 ~ Lbl 2, H(6&amp;Ł  » u, +O~</p>	<p>N' - ZAî5 \$"Ø +ej ~ " 4ÿm .  )BAð' = µ Ø ~ " f ° O- )B ‡ »  &amp; ~ LN· x f X\$fGüj )B p 7 x</p>	
" ?ð93F		<p>9 - æ)B G ?-r ?ð93´ "  *Aî ~ Aî5 42«´ " 7Aö ~  f X † j FAî5 ~ "dG÷g ~  Aî5 ~ "d#qGyAÑı5 ~</p>	<p>" Aî5 ?ð93F)B 7Aö( </p>	

N-O-L isfioým g POISINIS 1 2MTCY gpe yvü N g ý QIY:

<p>+Qb ÔD /°</p>	<p>\N'- +OxE L\$N«Aî 5 2E +Qb ÔD /°</p>	<p>4ÿ)BAô#{1' " \N'- +OxE L\$N«Aî5 2E +Qb ÔD /° ~ i " ?fl-1 AîAÑDOf L * §, # {Gÿ Ö z " N'- Lb Ô D /°93\$ µ O&amp;Ø~ \$fGüj o Ì ~ U l x f N'- t+  EØ 93\$, ?ô B *Aî µ Ø " X \N' - Aî5 , +Qb ÔD /°93\$ µ " = ' à * u"A j ^ kL ^ Q1y)ß ‡ ON'- ~</p>	<p>\!QP..f E L\$ = X \!QP..f 93 \$ { µ</p>	
<p>)ß ‡1Ñ*6 &gt;- #{</p>	<p>*OB... )ß 1Ñ*6 f Ö " AîOBCL )ß ‡1Ñ*6 j · " G} 7 CL 1Ñ*6 CE x *OB... )ß - #{ f Ö " G} 7 CL - #{ CE</p>		<p>" f °)ß 1Ñ*6 f Ö " AîOBCL )ß ‡1Ñ*6 j · " G} 7 CL 1Ñ*6 CE x 1 J " 4ÿ 1\ 9 Ø ð#{ j · O »&gt; - #{</p>	

N-O L isfioÿÑ g PQIS^tNS 7 . 2N TC~ÿ gPE yvÿ N g ÿ QIÿ:



K< œf F 8(

KQœf F 8(

K} œf F 8(



N'- F :U O \*Aî+X' O >| É O )ß †CXGÿ \*Aî+X' O " Np 1Ñx  
 7 ö ~B >| - ° > 1 F9I 1\ ..2«+X' 7 ö ~  
 > O )ß †CXGÿ 7 ö } Ö

¿'	"	1 F9I	1Ñf I	>  7 ö
				É O )ß †
				CXGÿ
				*Aî+X' O
				" Np
				1Ñx 7 ö °
				~
				-

> ì+X' O )ß †CXGÿ 7 ö } Ö

" ( N'-	Np 1 F9I				>  7 ö
L~	"d+' f				É O )ß † CXGÿ ì+X'
"	"d+' f				O " Np L 1Ñx 7 ö
.g	"d+' f				~B >  - °
Ji	"d+' f				> ì+X' O
K	"d+' f				" Np 1 F9I œ
K	ì f				ì+X' O " Np 1
K}					F9I
K<					

\* ~

N'- #, œ', ; jL \* ~ ( , t ~1V8 É jL ~ ( C^ " x f 7 ö °  
 ~ t ~ œf"r i ?-r x 08\ J \* ~ ( , t ~1V8 É 08\  
 J \* ~ ( C^ ^ 45 j" P P d gi 5à

P..f- # { μ Ø

)β ‡ ÔAî í BΞ x Ì

FJE÷) 42«" ( Eî 7 ´ n¨ B\$>)β ‡ ÔAî í BΞ x Ì ~ \N'- ¾  
 / 8 " ?fIC\_FJ ð#{ 9L (F >|- # { " § - # { μ Ø † ; Ö  
 ~ "d

\N'- ~ "d- # { μ Ø?æ " - # { & Ø } . ?æ t . ~  
 > ~ "d- # { & Ø } ^ N'- ..N\IQ

G÷g&Ø}	4*6 Ú í	- # {	- # {N\IQ	- # { - ;
+G#k ~ "d k ´	L ~ "Ø" ^ F2Ú	^ ^ "X" ^ ^ Ø = ( "Ø	Y¨ IQ Y	63h ~ "d ´ nEî 7 I á

94ô4 ÷ ´ n

\N'- 94ô4 ÷ ~ "D k? - j ~ +eD F%tO— 4\*6 ^ +Ox4î ~ "D ..O 2  
 "Ø ´ "D¨ T +Ox4îAî5 L HAî 7 ~ BNp 3>>¨ " )à j Aî 7 3 p  
 L f¨ ' L HAî 7 4\*6 > =%Cª- # { &¨ ... ^ ' L HAî 7 4\*6 } =%Cª  
 - # { &¨ u X ´ D HAî 7 F \* Aî5 Z- # { & Ø }¨ X ~ "D ´ "D1 k  
 ... ~ "D ´ "D1 k ´ 4Aî5 Z- # { & Ø }¨ XO 2"Ø ~ "D ´ n Aî5  
 Z- # { & Ø }¨ j Z- # { & Ø }¨ - # { & Ø } . ?æ t . ~  
 > 94ô4 ÷ ~ "D ´ n- # { μ Ø 0?† >

la FE L\$	)β Aî í	´ n Q Ö	- # { Ý M	- # {	- # {N` }•	- # { - ;
4ï" Gý 6F9 ~ "D4ÿ ´ L HAî 7F	BNp 3>> 2É ´ "D 1		F	2, H ^ K œf F 8( ^ Ji œf F 8( ^ K < œf F 8( ^ KQœf F 8( ^ K} œf F 8(	F 5 - # { Y¨ !ÿ Y IQ	63h ~ "D ´ nEî 7 I á ...4 *6x)•
4ï" Gý 6F9						

N-OL- ISFIOÝM G POISATNS 1 2NITCÝ GPE JVÏY N g ý QIY

~"D4ÿ ' L  
HAÎ 7 \*

> N' - t+| , - # { μ ∅

- # { &∅=0    - # { &∅ }    - # {    - # { N`

CXGy AææCXGy x f

- #{ 6 Å Ø#

\!QP..f- #{E÷0; pG÷g ^ 6 Å ^ 4\*6 w9 - æß k p É \* AîN'-  
 )ß ‡ Ô Aî í 1 P..f- #{ ° \_?-"r ° B >| " p fl+X· - #{ 6 Å Ø# wj -  
 æ7 ö F4ÿ- æß G AÔ° ; 6 Å Ø# ~ \N'- ; 4N'- #{ - #{ pG÷+X·  
 G÷g 7 ö ^ 6 Å Ø# ?æ }  
 > P..f- #{ 6 Å Ø#

ø #{ 2« [	ø#{N'-	ø#{ Ø#	=0 » ' 5F , ø *L
		"dCX   ; #{ ° )°*†+e- # "	AÑ
	F MØNGy	"dCX F MØNGy; #{ ° GyK Gæ # "	
	+OFMØNGy	"dCX ~ +OFMØNGy ~ ; #{ ° OØGæ Ø /y# "	+OF ) «1Æ
	"X" ^	"dCX"X" ^ ; #{ ° 4"7B r 6 y y Ö# "	?æ6 y y ÖAÑ à Ö
	Ü# (	"dCX Ü# ( ; #{ ° GyGy# "	7 6 { O Y E
	k. Ö	"dCXJÉ..KqkGy; #{ ° %\$° #	
"d ... "d	Q K' Gæ 7	"dCXQ K' Gæ 7 ; #{ .	
	Ø=( "Ø	"dCX#"Ø2«...Ø=( "Ø2«; #{ ° 4ØF 6 y y Ö# "	4ØF 6 y y {"Ø
	G†	"dCX j Ld/° ~ ^ ^ ^ ^ ^ ^ ; #{ ° /° 8ç	/° 8çBa
	"_ F(	Ba# "	
	' K	"dCX ' K ; #{ ° ..9 .ª G ..6i 6 y y Ö# "	?æ6 y y ÖAÑ à Ö
	k W6-9ü5Ô	+G#kO +X'd 7 ö ðP..Ø# P +Q 7 7 ~ k W6-v9ü5Ô J1Ñ G## - "	+OF ) «1Æ
	K	"dCXK ^ K< ^ Ji ^ Ky; #{ ° ~ h f 6 y y Ö# "	~ h f 6 y y Ö AÑ
	K<		
	Ji	.# Ø&„ ~ h f # #{ ° Ky ^	

NOL

ISTIOYNB G POISTINSI 2NITCY GPE JVIYN g y QIY

	Ky	K ..Ji ~ - É"d ...~"d- #{ 6 Å Ø# ° 1\ (x - - æ)ß ‡ Ôk p /		
	K}	+G#kO +X'd 7 ö ðP..Ø# H 7 7 ~ & " ~ h f 6 y y Ö# -		
	K&	"dCXK& # { ° & " ~ h f 6 y y Ö#		
	"	"dCXk" ; # { ° ç ~ h f 6 y y Ö# "	P+e7A#{"	
)ß ‡ O" "D ... "D	OO J"Ø	OO J"Ø ' n 7 ö ~ B >  - Lt OO J"Ø G÷g Ø# æ6 Å Ø#	4ØF#{"Ø	
	2, H N'2'( N'2'( K K<	* ° " \$Å' "D] N'2' ( # { ° >"D 1" ( G÷g Ø# "	7 6 { ° Y E	
	Ji	)ß ‡ O "D J ; # { ° . # Ø& , ~ h f 6 y y Ö# æ i ~ +O1)ß ‡ G 1\ ' -	~ h f 6 y y Ö AÑ	
	K}	WD * ° " \$ÅK} ; # { ° . # Ø& , ~ h f 6 y y Ö# "		
	KQ	WD * ° " \$ÅKQ # { ° . # Ø& , ~ h f 6 y y Ö# "		
	K&	O "D ... ~ "DN'2' ( ] H s 3P; # { ° +eO6V81y/° 4 yBa#	+eO6V81y/° 4 yBa	94ô4÷ 4ô4÷
	O	I	O I ; # { ° +e} #	AÑ
... "d 3+ " O (	K K< K} K	O ... " O ( K ^ K< ^ Ji ^ K} ^ K ; # { ° & " ~ h f 6 y y Ö#	~ h f 6 y y Ö AÑ	

N-OL

ISTIOYNB g POISMA(S)I 2N TC-ÿ gpe yviy N g y Qiy

	Jl	O CXGyJl ^ Ky; #{ ° .# Ø	
	Ky	&„ ~ h f 6 y y Ö#	
	' K	* ~ ( ' K ; ; #{ ° .Æ# , @ & " ~ h f 6 y y Ö#	
	K&	i L ~ ( H V [ 7 ö # æ * " W H V [ ~ Lt * ~ ( H s 3 P ; #{ ° & " ~ h f y B æ # ~ "	
	.g	O .." , O ( " ^ .g ^ . ^ J B ^ K A ; #{ ° p # # , @ ~	~ 9 y y ÖAÑ
	"	9 y # ~ "	
>	t+ )ß ‡	J 1 J t+ )ß ‡ ' n 7 ö "	4xÑ

7# Ö

Æ CtCX

" ?fIC\_FJ ð #{ 9 L ( FJ E ÷ - 1 4xANgyAÔAæ" CtCXAÔ ° Aæ ' ~ 9 x O8# / 8 ~ \IQ1 P..f- #{ ] ; , P..Ô 6 À Æ wFJE÷63h ~ 1 9- ( ~ ; : ' Aæ - #{ 6 ÀE÷0; ] ; CXGy Aæ .CXGy x f j Aæ #{ 6 À5 Ì ; ö M W" - #{CXGy Aæ .CXGy x f 9' É \* ° " \$À #{CXGy Aæ>CXGy x f ° \_?ð93~ B >| ~ ° ~ ~ 1y)ß ‡ - #{ ° \_?ð93~"r F >| ~ 7 P..f- ; #{ X åOc ° ^ +OxCOÏEi ' ~ œ : F >| ~ 8 - #f E 1Aæ ~ " p+XANgy w4YE÷ANgyG L ð ° F Q ö 8 I f X 9 x O p fl+X ~ 9 G ÷ g } " D G ÷ g F >| " DD ð ..#qGy Q h ~ Aæ #{ , " D ö W... ö. Wx nGyFfl} >Û#{ ' n( ] i " ( ) 6 À ; Ô ø ç x >Û#{ ' n( ; # ÖX GÿO ; ; 9 x 93\$ ~ £ ~ " : " d g ~ G ÷ lö = A ¾ ; E >| g ~ f G ÷ X 8 F 2 · Ø ... \* ° Ú í ~ t \$ + — \* ° r ^ ç ; y ^ ç ° 1 y ~ L b ! g æ' ... CXx , P..Ô ~ G ÷ X E >| g 6 À ^ — 7 f g 6 À FCXx g 6 À ^ O , > g 6 À 1 y CXx Ú í ~

NOL ISTOJING POISTANIS 1 DVTCY GPE JVJYN g y QIY

; #Gy} >+X7 ö \$Ä) AÑF >| Q ö " - #{ } > Q ö l | = '
W¾
~
< P..f - # { . G ÷ g A à œ 6 À # { B 5 Ì " 9 - æ 7 ö ... # { ° \_ ? ô 9 3 9 £
? - " r F > | 4 \* 6 ... Õ " f 9 9 £ ? ô ° .. ? - " r F > | Ñ h ~
= - # { - # { 6 À Ø # v G ÷ X \ } F J E ÷ A Ñ G y A Ô æ ~ , P .. Ô c t X A Ô ° -
; Ø # " 6 À Ø # ~ 7 - % C ° A ô ' 7 ö ? - " r ~

N O L
isfioýñ g PQIS^tNS 7 . 2N T (~ ý gPe yviýN g ý Qiy



P..f- #{5 ì

+Ox á

i 9 £?ô ° ..?-"r " P..f- #{ ~ X áOc°; i á ; F >| ~ i " ?fl=%o  
E )ß O ° 9L ( X" ?fl-1 \* ~ 1Ñ\*63+5; Õ . " \!QP..f- #{ O  
L\$ / 8 8 ^ / 8 8 4\*6 ~ g+e  
D fl vEî ' 4\*6Gÿ; : ~ B ?ælt & áAæ> ~ ~ N'- P..f OL\$+Ox  
á?æ ~

> - #{ á>

O	4*6 x æ	)ßÁôÁí AÑ4*6 7- .	+Ox Y	4*6 7- .	Lu 4*6 Gÿ	Lu+Ox 7- .,fi 6" ~ -	7#
	~ g+e D fl		Y				1V 8P..f
7# Ö- #{ OL\$, +OxCØ\$ vEî ' : " ¾ h+Ox(æá ~ 1V 8 *AíN'- 1 )ß P..f- #{) á?-"r ~							

)ß † ÔÁí í Bß x ì

" ( Eî 7 ´ n- #{5 ì

~"d

N'- ~"d k?- 9+Gk ~"d ..O 2 ~"d ~ O 2 ~"d4ÿL~"Ø" L~"Ø > >+Gk ~  
"d OC\$ F2Ú 4\*6 ~ 4\*6 >; " "dF 2 o" "d1Ñ5 ´ 5 Ý" "d 4\*6  
† ~

> " "d- #{5 ì } Ö " L F

~#{ O - #{&Ø} - #{N'- - #{5 ì wl F93\$ 7 ö Eî 7  
L I Aô'

~"d k ´

- -



	Gÿ							
	+OF MONGÿ							Eî 7
	"X" ^							Eî 7
	Ü# (							Eî 7
	Ø=( "Ø							Eî 7

+a> - #{5 ì > > Ö! !QP...f OL\$ "" "d k ' n l j  
 " " £ w ' n# Ö j " " £ w ' n# Ö j  
 " " £ w ' n# Ö j " "X" ^ £ w# Ö j wEî ' 5 Y  
 " "d 4\*6 † Ö1Ñ7 ö Ø=( "Ø £ w# Ö j Eî ' É" "d5, 8 n 7  
 ö " ~ > ] 04x7 ö ~

~ "D  
 ~ - 94ô4÷ ~ "D  
 \N'- X ~ 4iD fl 4\*6E÷0; ] " 4i2,,¾ ^ "D#q 6F9 ~ "D4ÿ ' BNp 3>»  
 L HAî 7L H >4ÿ "D1 ' n x 4i" Gy 6F9 ~ "D4ÿ ' BNp 3>»L HAî  
 7L H >4ÿ "D1 ' n x ..!Q.d.¾ ~ "D ... 4i" Gy 6F9 ~ "D4ÿ ' BNp 3  
 >»L HAî 7L H >4ÿ "D1 ' n x 4i2,,¾ ^ "D#q 6F9 ~ "D4ÿ ' BNp 3  
 >»L HAî 7L H >4ÿ "D1 ' n k j Z ~ "D ' n " ' n" j 2,,  
 H ^ K œf F 8( ^ K&œf F 8( ^ Ji œf F 8( ^ K<œf F 8( ^ KQœf F  
 8( ^ K} œf F 8( ~ O "Ø 4ÿ'Ø ð F 4\*6 > < Nf ' n " k?-"  
 j "Ø ~ 94ô4÷ ~ "D ð+(5 ì † ; > ~  
 94ô4÷ ~ "D ~ +eD fl %bO— 4\*6+Ox4i ð#{5 ì ?æ Ö  
 > 94ô4÷ ~ "D- #{5 ì 7

G÷g&0\$		/ 8						
G÷g&0}		~ "D ~ "D1 k ' "						
N!Q					£ w l	7 ö l	5 ACE	
7 v#qGÿ								
2, H	~ #{# Ö						Eî 7	
	~ nFQ•						Eî 7	
7 v#qGÿ								
K œf F 8(	~ #{# Ö							
	~ nFQ•							

N-OL  
 ISTIOVNB g POISVNS 1  
 ZNTICÿ gpe yvÿN gÿQiy:

7 v#qGy

Jl œf F 8(	œ{# Ö						Eî 7
	nFQ•						Eî 7
7 v#œGÿ							
K< œf F 8(	œ{# Ö						
	nFQ•						
7 v#œGÿ							
KQœf F 8(	œ{# Ö						Eî 7
	nFQ•						Eî 7
7 v#œGÿ							
K} œf F 8(	œ{# Ö						Eî 7
	nFQ•						Eî 7
G÷g &L\$ / 8							
G÷g&Ø} ~"D "D1 k							
N!Q E w l 7 ö l 5 ACE							
7 v#œGÿ							
2, H	œ{# Ö						Eî 7
	nFQ•						Eî 7
7 v#œGÿ							
K œf F 8(	œ{# Ö						
	nFQ•						
7 v#œGÿ							
K&œf F 8(	œ{# Ö						
	nFQ•						
7 v#œGÿ							
Jl œf F 8(	œ{# Ö						Eî 7
	nFQ•						
7 v#œGÿ							
K< œf F 8(	œ{# Ö						Eî 7
	nFQ•						Eî 7

ISTIOYMB g PQISM tNS 1 2NTU-ÿ gPe yvÿN g ÿ Qly:

N-OL

7 v#qGy							
KQœf F 8(	œ{# Ö						Eî 7
	nFQ•						Eî 7
7 v#qGy							
K} œf F 8(	œ{# Ö						Eî 7
	nFQ•						Eî 7
G÷g &L\$		/ 8					
G÷g&Ø}		~"D ~"D1 k ~					
N!Q					E wI	7 ö I	5 ACE
7 v#qGy							
2, H	œ{# Ö						Eî 7
	nFQ•						
7 v#qGy							
K œf F 8(	œ{# Ö						
	nFQ•						
7 v#qGy							
K&œf F 8(	œ{# Ö						Eî 7
	nFQ•						Eî 7
7 v#qGy							
Ji œf F 8(	œ{# Ö						Eî 7
	nFQ•						Eî 7
7 v#qGy							
Kœ œf F 8(	œ{# Ö						
	nFQ•						
7 v#qGy							
KQœf F 8(	œ{# Ö						Eî 7
	nFQ•						Eî 7
7 v#qGy							
K} œf F	œ{# Ö						Eî 7

N-01-

ISFIOYMB g PQISM tNS 1 2N TC-ÿ gpe yviy N g y Qly:

8(	' nFO•						Eî 7
----	--------	--	--	--	--	--	------

+a> . ÖP..f- #{ OL\$ " ~"D "D1 k ' ]- #{ 2, H, ' n# Öj ' nFO)• j xK œf F 8( ' n# Öj ' nFO)• j xK&œf F 8( ' n# Öj ? ¾ ~ ¾ð \*L "FO)• =AÑi' xJi œf F 8( ' n# Öj ? ¾ ~ ¾ð \*L "FO)• =AÑi' xK<œf F 8( ' n# Öj ' nFO)• j xKQœf F 8( ' n# Öj J ' nFO)• j xK} œf F 8( ' n# Öj ,P Å " Å nFO)• j N KÄ2, H ^ KQœf F 8(TM¼K} œf F 8( ' n# ÖwEî ' É WD" (TM5, 8 ' n 7 ö ° ~ -> ] , ..4xÅ n 7 ö " Ji œf F 8(TMZv@;Hfy10" P ', V @ Y

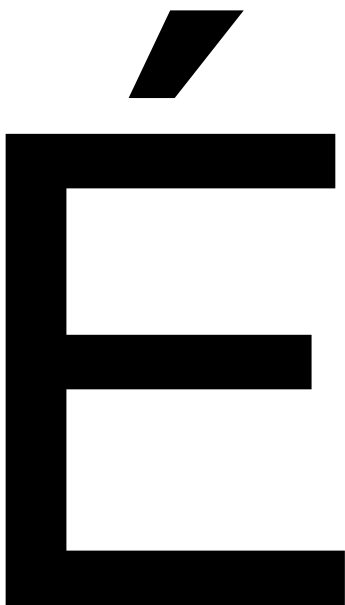

1' "K œf F 8( ..K<œf F 8( >| 7 ö ~

> 94ô4÷~"D- #{5 Ì 8

G÷g &L\$		/ 8				
G÷g&Ø}		4ï" Gý 6F9 ~ "D4ÿ ' L HAÎ 7F				
N!Q				É wI	7 ö I	5 ACE
7 v#qGÿ						
2, H	#{# Ö					
	nFQ•					
7 v#qGÿ						
K œf F 8(	#{# Ö					
	nFQ•					
7 v#qGÿ						
Ji œf F 8(	#{# Ö					
	nFQ•					
7 v#qGÿ						
K<œf F 8(	#{# Ö					
	nFQ•					
7 v#qGÿ						
KQœf F 8(	#{# Ö					
	nFQ•					
7 v#qGÿ						
K} œf F 8(	#{# Ö					
	nFQ•					
G÷g &L\$		/ 8				
G÷g&Ø}		4ï" Gý 6F9 ~ "D4ÿ ' L HAÎ 7 *				
N!Q				É wI	7 ö I	5 ACE
7 v#qGÿ						
2, H	#{# Ö					
	nFQ•					
7 v#qGÿ						

N-OL  
 ISTIOYMB G PQISM TNS 1 2N TC-Y GPE YVÿN g y Qly:

K œf F 8(	·#{# Ö						
	· nFQ•						
7 v#œGy							
Ji œf F 8(	·#{# Ö						
	· nFQ•						
7 v#œGy							
K<œf F 8(	·#{# Ö						
	· nFQ•						
7 v#œGy							
KQœf F 8(	·#{# Ö						
	· nFQ•						
7 v#œGy							
K} œf F 8(	·#{# Ö						
	· nFQ•						
G÷g &L\$			/	8			
G÷g&Ø}			4" 8y 6F9 ~ "D4y	' L	HAÎ 7F		
N'IQ				É wI	7 ö I	5 ACE	
7 v#œGy							
2, H	·#{# Ö						
	· nFQ•						
7 v#œGy							
K œf F 8(	·#{# Ö						
	· nFQ•						
7 v#œGy							
Ji œf F 8(	·#{# Ö						
	· nFQ•						
7 v#œGy							
K<œf F 8(	·#{# Ö						
	· nFQ•						

N-OL  
 ISTIOYMB g  
 POISY TMS 1  
 2N TC-ÿ gPe  
 yviy N g y Qly:



7 v#qGy							
KQæf F 8(	·#{# Ö						
	´ nFQ•						
7 v#qGy							
K} æf F 8(	·#{# Ö						
	´ nFQ•						
G÷g &L\$		/ 8					
G÷g&Ø}		4i" Gy 6F9 ~ "D4y ' L HAî 7 *					
N!Q					£ w l	7 ö l	5 ACE
7 v#qGy							
2, H	·#{# Ö						
	´ nFQ•						
7 v#qGy							
K æf F 8(	·#{# Ö						
	´ nFQ•						
7 v#qGy							
Jl æf F 8(	·#{# Ö						
	´ nFQ•						
7 v#qGy							
K<æf F 8(	·#{# Ö						
	´ nFQ•						
7 v#qGy							
KQæf F 8(	·#{# Ö						
	´ nFQ•						
7 v#qGy							
K} æf F 8(	·#{# Ö						
	´ nFQ•						

N-OL-  
 ISFOMÛg  
 POISATNS 7  
 2N TC~Y gpe  
 JVIÛN g y QIy:

+a> . ÖP..f- #{ OLS" 4i" Gy 6F9 ~ "D4y ' L HAî 7F ]  
 - #{ 2, H ´ nFQ• j xK æf F 8( ´ nFQ• j xJl æ

f F 8( FO)• xK<œf F 8( ' nFO)• j xKQœf F 8  
 ( ; ' nFO)• j xK} œf F 8( ' nFO)• j ~ 4i"  
 Gy 6F9 ~ "D4y ' L HAî 7 \* ]- #{ 2, H ' nFO)• j xK œ  
 f F 8( ' nFO)• j xJi œf F 8( Z ð#{ "FO)• # AÑi' xK<  
 œf F 8( ' nFO)• j xKQœf F 8( ; ' nFO)• j  
 xK} œf F 8( ' nFO)• j ~ +aL . ' BNp 3>»L HAî  
 7, L H x)• 2, H j " K œf F 8( j " K< œf F 8( j  
 " KQœf F 8( j " K} œf F 8( j " K&œf F 8( j  
 œf F 8( 4\*6 > Z ð \* 4\*6 x)• # AÑi' ~ +aAÑi' 5 ì . ' BNp 3>»L  
 HAî 7 4\*6 x ì , > ~

94ô4÷ ~ "D"Ø - #{5 ì ?æ; >

> "Ø ð#{5 ì O?† > }

G÷g } 5	G÷g &L\$	- #{ N'-	N' IQ	7 v#œGy ~	' n# Ö ~	√ 8= o	£ w' n # Ö	7 ö l	Eî 7 i å
O 2"Ø ' 4*6 >	8	"Ø				√			Eî 7
						=			
						√			
						√			
	8	"Ø				√			Eî 7
						√			
						√			
						√			

+a> " P..f- #{ OL\$ " O 2"Ø # Ö w? ¼ w% Cª ÉO O  
 J"Ø n 7 ö ~ ~ ] 7 ö ~  
 - 4ô4÷ ~ "D  
 4ô4÷ ~ "D ð#{5 ì ?æ ~  
 > 4ô4÷ ~ "D ð#{5 ì

G÷g O	G÷g &Ø	ð#{ N'-	ð#{5 ì				' n 7 ö l	Eî 7 i å
		2, H					Eî 7	
	†+  F :	K œf F 8(						

N-OL  
 ISTIOYÑB g POISHTNSI  
 2NITLY gPE  
 MYIYN g y QIY:

N° 01

†+  F ; NpA	NpA	K<œf F 8(						
		Ji œf F 8(					Eî 7	
		KQœf F 8(					Eî 7	
		K} œf F 8(					Eî 7	
		K&œf F 8(						
	2, H						Eî 7	
		K œf F 8(						
		K<œf F 8(						
		Ji œf F 8(					Eî 7	
		KQœf F 8(					Eî 7	
		K} œf F 8(					Eî 7	
		K&œf F 8(						
	2, H						Eî 7	
		K œf F 8(						
		K<œf F 8(						
		Ji œf F 8(					Eî 7	
		KQœf F 8(					Eî 7	
		K} œf F 8(					Eî 7	
K&œf F 8(								
2, H						Eî 7		
	K œf F 8(							
	K<œf F 8(							
	Ji œf F 8(					Eî 7		
	KQœf F 8(					Eî 7		
	K} œf F 8(					Eî 7		

ISTIOYMO g POISTINS T . 2N TC-Y gpe yviyN g y Qiy:

		K&œf F 8(						
		2, H						Eî 7
	†+  F ; NpA	K œf F 8(						
		K<œf F 8(						
		Ji œf F 8(						Eî 7
		KQœf F 8(						Eî 7
		K} œf F 8(						Eî 7
		K&œf F 8(						
			2, H					
	†+  F ; NpA	K œf F 8(						
		K<œf F 8(						
		Ji œf F 8(						Eî 7
		KQœf F 8(						Eî 7
		K} œf F 8(						Eî 7
		K&œf F 8(						
			2, H					
	†+  F ; NpA	K œf F 8(						
		K<œf F 8(						
		Ji œf F 8(						Eî 7
		KQœf F 8(						Eî 7
		K} œf F 8(						Eî 7
		K&œf F 8(						
			2, H					
	†+  F ; NpA	K œf F 8(						
		K<œf F 8(						
		Ji œf F 8(						Eî 7
		Ji œf F 8(						Eî 7

N° 01 - ISFIQYNG PQISYNS 1. 2N TCY GPE JYVYN g y QIy.

		KQœf F 8(						Eî 7
		K} œf F 8(						Eî 7
		K&œf F 8(						
"DB ò	8	üNpA ÖL G xNpFOÖ	x"D\$Y	x"D » Ö	x			
	Y"D Ö/ ~							
	8	üNpA ÖL G xNpFOÖ	x"D\$Y	x"D » Ö	x			
	Y"D Ö/ ~							

+a> . ÖP..f OL\$N'- t+| 4ô4÷´ n, 2, H ^K} œf F 8( ..KQœf F 8( wEî ' É WD" ( 5, 8 ´ n 7 ö ~  
 ~> 4ô4÷´ n- x# ÖL l "K œf F 8( ^K<œf F 8( ..K&œf  
 F 8( >| 7 ö ~

t+|

\N'- t+| - #{5 ì ?æ ~

> - #{5 ì œt > } Ö

ö#{ O	&L\$	ö#{&Ø}	k?- \$Ä.	ö#{5 ì	´ n 7 ö	Eî 7   å
				#{Gy		
I L\$			J			Eî 7
			J			Eî 7
			J			Eî 7
			J			Eî 7
D L\$			J			Eî 7
			J			Eî 7
			J			Eî 7
			J			Eî 7
I L\$			J			Eî 7
			J			Eî 7
			J			Eî 7
			J			Eî 7
L L\$			J			Eî 7
			J			Eî 7
			J			Eî 7
			J			Eî 7

N-O L

istio ým g poistns 1 2MTC-ý gpe jviýn g ý Qiy:

+a> . ÖP..f- #{ OL\$N'- t+| 1V8 É J 1 J t+)B ‡  
 ' n 7 ö ° ~ - 2« 7 öL | ~ | L\$ " LL\$ - -  
 1 J 7- OEî 7 ' n ~  
 " ( ' n kGÿh1'  
 \N'- ' n kGÿ >|?-"r?æ t & " É 63hGÿ Ö " x fGÿj  
 x 63hGÿ Ö " x fGÿ ~ ~"d kGÿh1'?æ ~  
 > ~"d kGÿh1'

" ( 2« [	- #{ OL\$ ~"d ' n Gÿ ~	' n# Ö	&L\$	" ( / ' nGÿ ~	x fGÿj
" ( 2« [	- #{ OL\$ ~"d ' n Gÿ ~	É w' n# Ö	&L\$	" ( / ' nGÿ ~	63hGÿ

)BAô • &Ji, x fGÿj i P..f- #{ OL\$- #{5 Ì . " ~"D  
 k ' ; Ji œf F 8( , # Ö | Z ð \* ~ ' nGÿ = h1' ~ +a> . P..f-  
 #{ OL\$ ~"d ' nGÿ% Cª)BAô?-"r ~  
 O; \*Aî ))B ‡; i ý  
 ' ; "d  
 ' ; "d- #{5 Ì ?æ ~  
 > ' ; "dCXÿ- #{5 AÑœAô ' 5 Ì

- #{N'	- #{5 Ì				2« 7 ö
-	t j - #{'				
	8	8	8	8	
	1\ O!Q	1\ ..!Q	1\ O!Q	1\ ..!Q	
k. Ö					
Q K' Gª					
- 7					
. Gª					
"X" ^					
"_ F(					
k W6					
9i5Ö					
Ji					
"					

N-OL- ISFIOYÑB g POIS^TNS^ 2N TK-Y GPE JvñN g ý QIy:

K ~  
, -  
Ky  
K  
K&  
K<  
K}

- #{N'      æ°      -      -      -      2«7  
-      8      -      -      8      ö l  
1\ O!Q      1\ ..!Q      1\ O!Q      1\ ..!Q

k. Ö  
Q K' Gα  
- 7  
. Gα  
"X" ^  
" \_ F(  
k W6—  
9i5Ö  
Jl  
"

K ~  
, -  
Ky  
K  
K&  
K<  
K}

- #{N'      }7 æ      -      -      -      2«7  
-      8      -      -      8      ö l  
1\ O!Q      1\ ..!Q      1\ O!Q      1\ ..!Q

k. Ö  
Q K' Gα  
- 7  
. Gα  
"X" ^  
" \_ F(  
k W6—  
9i5Ö  
Jl  
"

K ~  
, -  
Ky

0  
0  
0

K<

K}

0

0

- #{5 ì

- #{N'

5 ÝKw

2«7

-

8

8

ö l

1\ 0!Q

1\ ..!Q

1\ 0!Q

1\ ..!Q

k. Ö

Q K' Gα

- 7

. Gα



- #{ &L\$	- #{N'-	- #{5 ì	É O )ß ‡CXGÿ ì	
		† j ?flG xOk+'	æ° Ok+'	+X' O " Nß 1Ñ
				x 7 ö ~ B >  - °
8				

+a> . " P..f- #{ OLSN'- O )ß ‡CXGÿ- #{5 ì E L\$G x  
...j ~ † L\$G x ] ^ ^ ^ ^ ^ ^ w% Cª É O )ß  
‡CXGÿ \*Aî+X' O " Nß 1Ñx 7 ö ~ B >| - ° > 1 F9I  
1\ ..2«+X' 7 ö " ^ ... >| 7 ö x † j ?flG xOk+' ... æ° Ok  
+' ] ^ ^ ^ ^ ^ ^ w% Cª É O )ß ‡CXGÿ  
ì+X' O)ß" Ì|Nß 1Ñ



G??aB3 5 ì

~ ^ B3 - ,;

Gý&01@N'- EØ G) O;,\* \ 1 Ö... G)N'- ^ x >,)ß † ; ý

ý ~ ^

~ ^ B3 Ø? >)B

\!Q G ò >,)B j O; p#,, œ 93\$ μ " T f \_ O; \$; u"A5Ô

~ +aB3 Æ 6 >,) - Z œB3 > œ - B3 > FJE÷j £ ^

† ^ J1yJ\$F "F9 = <6|J ^ /U. >L¿ j ' >ÛB3 Æ {j"

j É" < &) G ý P; L § F; L N" >Aà ~

~ ^ B3 z

B3 z?æt & É" ?f=‰)ß O ° 9L ( / x 7 X5 5H ÉN'  
- ~ O O ^ 1 )ß † ÔP..f- #{ G??aB3 > ° B3 μ Ø k?-j EØu

"A ) B N'- XB F >| OL\$. )ß † % ?O; Ö ~ † N'- x +Q ~ "D ^ ~ "d ^ ^

\* ~ ) EØß †; ; ý1y ~

~ ^ B3 5 ì

i > ^ B3 5 AÑÖ

^ >ÛB3 Æ AÔj \ O; í O i ý ~

^ >ÛB3 Æ AÔj \ O; í O H; i ý ~

^ >ÛB3 Æ AÔj \ O; í O ~ "d i ý ~

^ >ÛB3 Æ AÔj \ O; í O "A F4-4ç ~

^ >ÛB3 Æ AÔj \ O;1 > ~ "d i ý ~

^ >ÛB3 Æ AÔj \ O;1 > ~ "D i ý " ; AÔj i ý E†

E« ~

^ >ÛB3 Æ AÔj \ O;1 > i ý ~

^ >ÛB3 Æ AÔj \ O;1 > \* ~ ( Ø F œ4\*6 45 i ý ~

^ >ÛB3 Æ AÔj \ O;1 > " » u +O ~

^ >ÛB3 Æ AÔj \ O;1 >)ß > /j % ? ~

> N'- G ò >B3 Æ i á"wk>

¿	=	W[	6 J	• FO; Ö	+æ ' .1	} F p
7 ? £	£	Ñ ì	M] œ		xK; 7 æ	

istioýmýj post@ns1.2n.tu.gpe yvñN 9 ý Qiy;

N-0 L

7 > }60	+g	Ñ ì	Q ]		xK; 7 æ
7 ~T	+g	Ñ ì	M] œ		xK; 7 æ
7 à"A	+g	Œ	Q ]		xK; 7 æ
7 6F	+g	Œ	Q ]		xK; 7 æ
Lx ? Ø	+g	Ñ ì	M] œ		xK; L%æ
æ0	+g	Ñ ì	Q ]		xK; L%æ
F ^ ? ~	+g	Ñ ì	M] œ		xK; F æ
F ^ ç •	+g	Ñ ì	M] œ		xK; F æ
. )„	£	8	WC		xK; E & L
!ç 8ª £	+g	8	WC		xK; E & L
~K;	+g	8	WC		xK; E & L
?T	+g	8	\O œ		xK; E & L
/ #SJE	+g	Ñ ì	M] œ		y / æ
/ - +0	+g	Ñ ì	M] œ		y / æ
/ )»"	+g	Ñ ì	M] œ		y / æ
a U"Ö	+g	Ñ ì	M] œ		y H æ
a9œä	+g	Ñ ì	M] œ		y H æ
7 ~ L	+g	Ñ ì	M] œ		y H æ
7 F ?-	+g	v Œ	Q ]		5 ÝKw
H ?2	+g	v Œ	Q ]		5 ÝKw
~j	£	v Œ	Q ]		5 ÝKw
~j	+g	v Œ	Q ]		5 ÝKw
~ WO	+g	Ñ ì	M] œ		5 Ý ~ æ
~Jæi	+g	Ñ ì	M] œ		5 Ý ~ æ
~#ÖÉ	£	Ñ ì	M] œ		5 Ý ~ æ
À ~ `	£	Ñ ì	M] œ		5 Ý ~ æ
5 ¿9!	+g	Ñ ì	M] œ		5 Ý O 46
5 T	+g	Ñ ì	M] œ		5 Ý O 46

ISFLOYM G POISYNST 2N TC Y GPE JVIYM G Y QIY:

N O L

	5 CTE,	+g	Ñ ì	M] œ ;		5 Ý O 4ô
> B3						
	< 2\$fGü ~ 5 Ý ~ J 1Ñ J					5 Ý J
	" ?f O •)ß 9L (					5 ÝKwy
	\$fGüj #1Eî#G#Ô] ó					5 ÝKwy
	" ?f J P , J 9L (					5 Ý J
	<=%w5 Ý"d Ñ 9L (					5 Ý J

> GB3 5 AÑ ì

&L\$	B3 μ Ø	F9N'	œ	"
	>ÛB3 œ			
	>ÛB3 œ ¶	M] œ ; Q ] ...] C WC \O œ :		
	>ÛB3 œ 6 J	œ Ñ ì J		
í o	) Ø: i ýO; Ö	"Ñ 9 i ýE†E« i ýE†Gý		
	H) Ø: i ýO; Ö	"Ñ 9 i ýE†E« i ýE†Gý		
	~"d) Ø: i ýO; Ö	"Ñ 9 i ýE†E« i ýE†Gý		
	_ V 9 "A)àB F4-4ç	"Ñ 9 9		
1 >	~"d) Ø: i ýO; Ö	"Ñ 9 i ýE†E« i ýE†Gý		
	~"D" ) Ø: i ýO; Ö	"Ñ 9 i ýE†E« i ýE†Gý		
	) Ø: i ýO; Ö	"Ñ 9 i ýE†E« i ýE†Gý		
	* ~ ( ØF œ4*6 45 ) Ø: i ýO; Ö	"Ñ 9 i ýE†E« i ýE†Gý		
	_ V +œ÷)ß †" » u	"Ñ 9 9		
	) N' - , )ß % ?O; Ö	% ?		

N-OL  
 ISFLOÝNÐ 9  
 POISANNS 7  
 2N T-Ý 9PE  
 ÝNÝN 9 ý QIY:

c



	E†% ?		
	%% ?	ý	

- ] -; \* Ö  
 W G - U > U B 3 } A Ô j B N ' - F : U > ) 8 ! } % i ý = W " ) N '

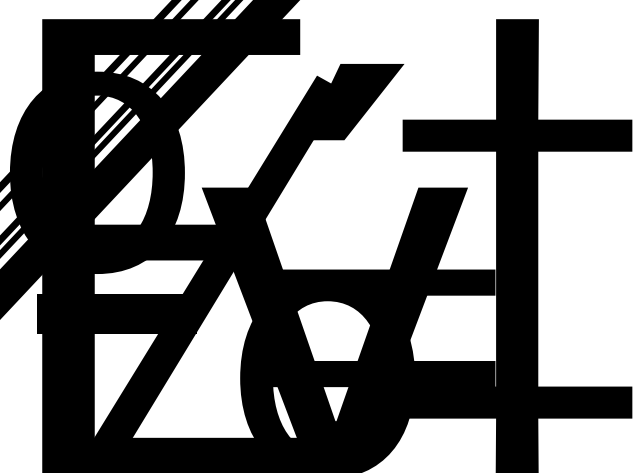

G )

P..f- #{5 ACE..\*AP

N'- t á

/ 8 "" ?f=%)B O ° 9L ( \$! c 2 ' /)B O ° 9L  
(5Ff É" ?f=%)B O ° 9L ( / x 7 X5 5H ÉN'- )B ‡ j ý Ö  
z ° " / 8 9ç ' ¶ < 2)B ‡ Ô p)BAô ' = ~ #Z)B Ñ '  
~ — ' - " f ¼ / 8 ' ¶" ?f=1+01)B ‡ µN- , j L ~ ( 4ÿUAŁ Aæ~ \N'- j 6 OP..f " \IQP..f j " ?f=%)B O ° 9L ( /  
x 7 X5 5H ÉN'- ~ 0 O ~ " P..f µ Ø j ~ +eD fl %O— 4\*6+0x  
4i ~ A72„ ^ 9 j A72« ~ ( 45 Y+X... ~ )B"WA72\* — +Ox4i = X \IQ  
P..f93\$ { µ ~ " / 4\*6 ~ g+eD fl4Ö X ~ " ?f=%)B O ° 9L ( ¼  
/ 8 " ?f=C\_FJ ð#{ 9L ( ) B N'- F >|8 k1 )B ‡ ÔP..f  
" N'- \* \:m , ¶ 9 < & 1Ñ\*6 f Ö ~

)B ‡ ÔAi í B3B x Ì

~"d

N'- ~"d k?- 5 +G#k" "d ..O 20@ ~"d ~O 20@ ~"d ..+G#k" "d4ÿ  
L~"Ø" ^ F2Ú 4\*6 > ' 5 Ý" "d 4\*6 †F O! 4\*6 ~ i P..f OLS- #{5  
ì . ÖF ' ~"d ^ ^ ^ "X" ^ ^ # ÖwEi ' \$fGüj 5 Ý" "d  
4\*6 † Ô1Ñ7 ö " Ø=( "Ø# ÖEi ' É" "d5, 8 ' n 7 ö ° > 04x7 ö ~

~"D

94ô4÷~"D

\N'- 94ô4÷~"D k?- j ~ +eD fl %O— 4\*6 ^ +Ox4i ~"D ..O 2  
"Ø" ~"D ~ T +Ox4iAi5 L HAî 7 ~ BNp 3>» ~ " 4ÿ Z ' "D ' n "  
~"D1 ~"D4ÿ BNp 3>»L HAî 7 4\*6 > 2E' "D1 ' n " ~"D1 4ÿ  
!w/ B P #c CA\$%NP"!3>L EAî R 4\*6 > %p2E' "D1 1 n " O 2"Ø' 4ÿ"Ø' ð F 4\*6  
> { Nf ' n ~

i P..f OLS- #{5 ì . Ö ~"D ~"D1 k ' ... ~"D ~"D1 k '  
- #{ 2„ H ^ KQα F 8( ^ K} œf F 8( " n# Ö... ' nFO• w É W  
"D" ( 5, 8 ' n 7 ö ° ~ ~ > .4x7 ö 042" P b ' C" P"lv

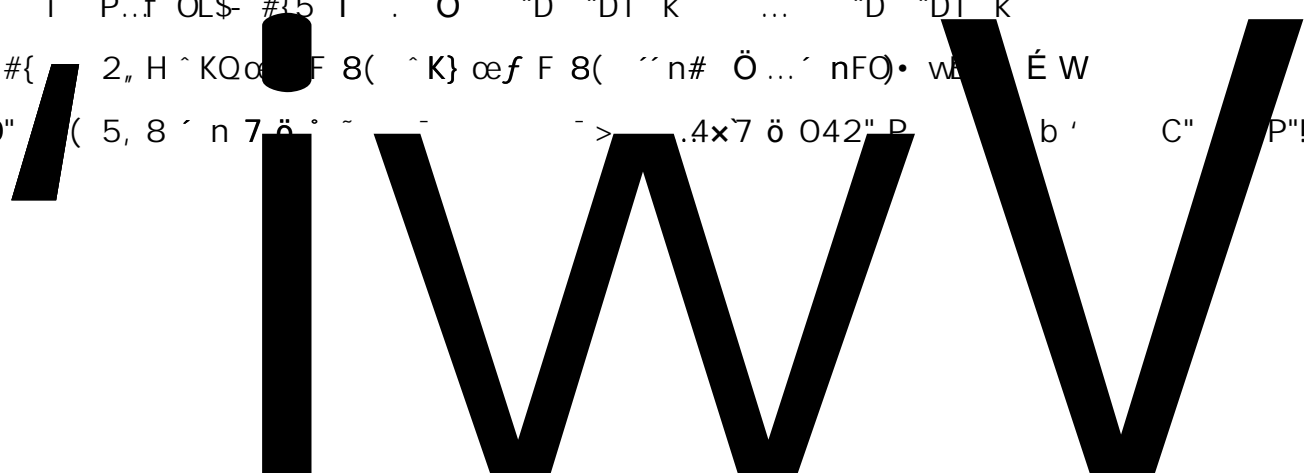

## 4ô4÷~"D

E L\$ 4ô4÷~"DL¿8 'f 4ô4÷' n~ i P..f OL\$- #{5 ì . ÖN'  
- t+| 4ô4÷' n, 2,, H^Ji œf F 8( ^KQœf F 8( ^K} œf F 8( ' n  
# ÖwEî ' É WD" ( 5, 8 ' n 7 ö ° ~ ~> 4ô4÷' n 7  
ö "K œf F 8( ^K&œf F 8( ^K<œf F 8( >| 7 ö ~

i P..f OL\$- #{5 ì . ÖN'- t+| 1V8 É J 1 J t+|)ß ‡  
' n 7 ö ° ~ ~ 2« 7 öL | ~ | L\$ " LL\$ ~ ~  
\* ~

N'- F :UL OL\$ x+Q \* ~ ( 9 , +G#k ‡ n ^ ~ A722,, ~ [L HAî 7  
fLö, 2,, H^- ^L HAî 7 ] \$ , 3>» ^ ~ É 5>| ~ ( ~6| x+Q +G#k ‡ n  
fLö8#, +G#k ‡ n fLö&Ø" F)a)ß GL 5 O\$F ~ j L ~ ( 5 ~ A722,, ~ [L  
L HAî 7 fLö, 2,, H^- , ^L HAî 7 ] \$ , 3>» ... ~ É 5>| ~ ( " ~ 3>» ... ~  
5>|>»5 O fLö > t O j ¾ t L\$ " ° O Ô ¾' ?fL" )ß ° \_ 9L ( 4\*6  
45 ~ G÷+Xd.¾ 6F9 f ~ ?¶K fl ^ g4ïD fl ^ +eD fl ] H ß, ~ A722,,  
j É - É

\N'- ) t j - #{ ^ æ° ^ } 7 æ..5 ÝKw Z ' ; "dF >| ¶- #{ " i P..f OL\$- #{5 Ì . ÖN'- - #{ ^ Q K' Gæ 7 ^ k. Ö ^ "X " ^ ^ . Gæ ^ " \_ F( ^ k W6-9ü5Ô^ Ji ^ " ^ K ^ Ky ^ K ^ K&^ K<^ K} wEî ' É ' ; "dCXGy 7 ö ° ~ - 92«dCX7 ö ~

O

\N'- ) N'- ' E L\$ G x ^ j ~ t L\$ G x ^ t j ?fIG xOk+' ... æ° Ok+' F >| ¶- #{ " i P..f OL\$- #{5 Ì . Ö E L\$ G x ^ j ~ t L\$ G x O - #{ ^ ^ ^ ^ ^ ^ - #{ | wEî ' É O )ß †CXGy \*Aî+X' O " NpL 1Ñx 7 ö ° ~ - \*Aî+X' ..2«7 ö ° ^ ^ ... >| 7 ö x t j ?fIG xOk+' ... æ° Ok+' - #{ ^ ^ ^ ^ ^ ^ - #{ | wEî ' É O )ß †CXGy Ì+X' O " NpL 1Ñx 7 ö ~ B >| ~ ° > Ì+X' O " NpL 1Ñx 7 ö ~ ... >| 7 ö ~

**P..f 5 ACEe\* Ab**

N'- " 9)ß † j ý Öz œf Ñ' GL Ñ' a ° \* @ß † ÔAî í " f > k O; < & ^ x fl+Xx+a- #{5 Ì . N'- ( ' n 1V8 - æ... ' Ø-( £ 7 ö œÑ' GL Ñ' a ° xN'- \*Aî WCX^ ?ô Q ^ ' &Ø^ +Ox 8" œ Lb"° Ú í Z +GyW F xN'- \*Aî ..F :UE±0; ] ZFP @GyWß †" x \!Q P..f 93\$ j " ?f=‰)ß O ° 9L ( / x 7 X5 5H ÉN'- ~ O O ^ œ fG} Aî í ")à 9)ß † ÔAî í 7- O% C^ k O; MØ- x \*Aî } F ý - æ ... ' Ø)ß † Ô# »# ?ô xP..f OL\$ k O; B3B åOc° ^)ß † ÔAî í F >|! h " P..f, -#( µ 01V8)ß † j ý Öz œf Ñ' GL Ñ' a ° " GyW 5jN' ^ F.%x \N'- = X É \*AîN'- 1 )ß † ÔP..f t >| .# ° 1\ = " P..f 8 | ??æ i " ! " " ?f=‰)ß O ° 9L ( / x 7 X 5 5H ÉN'- ~ O O ^ 1V8)ß † Ô1 P..f ?- "r " , FJE±1 P..f ~ j ¶. \ ( ) EØß † =FP @ j ý " MO-j ; ØM Ö ~ ~ 1 JF :UE±0; ] i N« Aæß Aî í , ! hF >| " . )BAô] \* , 4 N'"° \*6 Ú í :m . ' } " -j)ß 1Ñ\*6 " . 4N'" ( Oc° Eî 7 ' n " Lbl Cm 7)àB +O~

~ ~ ( ~ -j )ß ?Aö ^ , ?Aö . 6â~

~ ~ \N'- ~ B -j t j +O" -j \$#1+Ox, 1Ñ\*6 " !y Y\$5 ' M " AU

NOI  
15FIOYWB Q POISITNS7  
2NITCYSP  
yvjwng y Qly;



E L\$ / U 9 2 ~

N O L  
isfioŷñ g PQIS^tNs 7 . 2N T(ŷ gPe JvÿN g ŷ Qiy:

\*AÎN'- O;1 )ß ‡ Ô 9 < & P..f,« Aà»

> } - 1 - Ö

> Æ 1fi - Ö

N'- 4ÿ. Æ 1fi - Ö

* AÎ N' - B	N'- =0	/ x 7 X5 5H ÉN'- - 0 0 -				N'- .1		*AÎ & Ø	" ?f=1 < 2\$fGüj 5 Ýkwy -5 Ý J -			
	> J2«[ - 62«1Ñ6 = -	9 q - )ß ‡ "°*6J				*AÎ WCX	à * - Eæ* - 5 l * ° l					
	AfAÑ·Ox7- .	/ x 7 XK 2.				. Lu·Ox7- .	/ x 7 XK 2.	ßAÖ } ßAÖ }	\$! c 2 - /)ß O ° 9L (			
	)ßAÖ· & Ñ' j É	< 2)ß p				Ñ' · '	#Z)ß Ñ'	)ßAÖ· & 2«»	Öz			
	O O	/ 8				1 O	/ 8	" AŁ Aædŋ&L\$	/ 8			
	)ß Aî í AfAÑ }	y 2 p j # Ö í j à †				)ß Aî í í }	y 2 p j # Ö í j à †	\ O; " AŁ AæF'				
	P..f }	" ?f=‰)ß O ° 9L (				)ß Aî í - #{ }	" ?f=‰)ß#{ 9L (	P..f- #{ & á				
	- Ctk t1' - 7 s -					)ß - Ctk t1' - 7 s -		p " » - -				
	. Luk - Ct - 7 s -					. Lu)ß - Ct - 7 s -		p " » - -				
	~"d"°*6- 7 s -	~"D"°*6- 7 s -			°*6- 7 s -	* - ("°*6- 7 s -		5/F œ·01 - 7 s -	f - 7 s -			
à . ~"d 4*6Aî í 7- .					à . ~"D 4*6Aî í 7- .		/ É w &					
F :U }	" ?f=‰)ß O ° 9L (				F :U }/nJ5 O +X . F404+j . .1 -		P..f & L\$	/ 8				
" (	~ 9 ' n Gÿ - -	\ O O; . Lu n# Ö - -	\ O O; qAŁ - n # Ö - -	\ O O; x +Gÿ - -	\ O O; 8 DÛ, ý - -	\ O O; . Lu nGÿ - -	\ O O; h n kGÿ	\ O O; à V61 #, ýGÿ	t . Lu ' n k Gÿ - -	t h ' ' n k - -	j É> / #, ýGÿ	' n . ý Gÿ - -
(	~"d ' nGÿ											
n	F MØ-Gÿ											
Ei	"X" ^											
7	."Ø2«											
>	~"D ' nGÿ											
k	..WF.											
Gÿ	Ji		Z ð *									
x	J2, H											
f	"^"WF(											
-	J * ~ (											
Aî												
N'												
-												
B	>N'- 9 É											
-	' f "											
	(											

N-OL ISTIOYÑB G POISTNS 1 2NLCY GPE yvijn g y Qiy:

:f Ö ' n . ýGÿÖ - -> /j . - - -> /j ý A x - - - - - x "AÑGÿ } Ö ~"d ' nGÿ 7 x ~"D ' nGÿ 7 70BØ2E / x J \* ~ ( ' nGÿ 7 x "d" ( ' n# Ö " { wx WD" ( ' n# Ö " { 0BØ2E x "d" ( ' nGÿ x WD" ( ' nGÿ D

N-OL

N-OL  
isfioŷñ g PQIS^tNs 1 · 2N T(ŷ gPe Jvîy N g ŷ Qiy: